

Universal Device Servers

HelloDevice Pro Series

(PS110/410/810)

User Guide

Version 1.1.1

2005-09-28

Copyright Information

Copyright 1998-2005, Sena Technologies, Inc. All rights reserved.

Sena Technologies reserves the right to make any changes and improvements to its product without providing prior notice.

Trademark Information

HelloDevice™ is a trademark of Sena Technologies, Inc.

Windows® is a registered trademark of Microsoft Corporation.

Ethernet® is a registered trademark of XEROX Corporation.

Notice to Users

Proper back-up systems and necessary safety devices should be utilized to protect against injury, death or property damage due to system failure. Such protection is the responsibility of the user.

This device is not approved for use as a life-support or medical system.

Any changes or modifications made to this device without the explicit approval or consent of Sena Technologies will void Sena Technologies of any liability or responsibility of injury or loss caused by any malfunction.

Technical Support

Sena Technologies, Inc.

210 Yangjae-dong, Seocho-gu

Seoul 137-130, Korea

Tel: (+82-2) 573-5422

Fax: (+82-2) 573-7710

E-Mail: support@sena.com

Website: <http://www.sena.com>

Revision history

Revision	Date	Name	Description
V1.0.0	2005-07-08	O.J. Jung	Initial release
V1.1.0	2005-07-26	O.J. Jung	Revision for firmware v1.1.0 release Description for Locating Server is added. Typo on RS-485 connection diagram and Max. allowed connection are corrected Descriptions for Modem Emulation mode command and IP Statistics are changed.
V1.1.1	2005-09-28	O.J. Jung	Typo on AT command in modem emulation mode is corrected

Contents

1. Introduction	7
1.1. Overview	7
1.2. Package Check List	8
1.3. Product Specification	9
1.4. Terminologies and acronyms	10
2. Getting Started	12
2.1. Panel Layout	12
2.1.1. PS110 Panel Layout	12
2.1.2. PS410/810 Panel Layout	13
2.2. Connecting the Hardware	14
2.2.1. Connecting to the network	14
2.2.2. Connecting to the device	15
2.2.3. Connecting the power	17
2.2.4. Accessing the System Console	18
2.2.5. Using the System console	18
2.2.6. Using Remote console	21
2.3. Accessing the Web Browser Management Interface	22
3. Network Configuration	24
3.1. IP Configuration	24
3.1.1. Using a Static IP Address	25
3.1.2. Using DHCP	26
3.2. SNMP Configurations	27
3.2.1. MIB-II System objects Configuration	28
3.2.2. Access Control Configuration	29
3.2.3. Trap Receiver Configuration	29
3.2.4. Management using SNMP	29
3.3. Dynamic DNS Configuration	30
3.4. SMTP Configuration	31
3.5. IP Filtering	32
3.6. SYSLOG server configuration	35
3.7. Locating server	36
3.7.1. Overview	36
3.7.2. Locating server configuration	36
3.7.3. Locating server communication protocol	36
3.8. NFS server configuration	37
3.9. TCP service configuration	38

4. Serial Port Configuration	40
4.1. Overview	40
4.2. Serial Port Configuration	42
4.2.1. Port Enable/Disable	42
4.2.2. Port Title	43
4.2.3. Host Mode Configuration	43
4.2.4. Remote host configuration	54
4.2.5. Cryptography configuration	55
4.2.6. Serial port parameters	59
4.2.7. Modem configuration	63
4.2.8. Port Logging	65
4.2.9. Port event handling configurations	66
4.2.10. Copy port configuration	69
5. System Administration	70
5.1. System Status	70
5.2. System Logging	70
5.3. Change Password	71
5.4. Device Name Configuration	72
5.5. Date and Time Settings	72
5.6. Factory Reset	73
5.7. Firmware Upgrade	73
5.8. User administration	75
6. System Statistics	77
6.1. Network Interfaces Statistics	77
6.2. Serial Ports Statistics	77
6.3. IP Statistics	78
6.4. ICMP Statistics	80
6.5. TCP Statistics	82
6.6. UDP Statistics	84
7. CLI guide	86
7.1. Introduction	86
7.2. Flash partition	86
7.3. Supported Linux Utilities	86
7.3.1. Shell & shell utilities:	86
7.3.2. File and disk utils:	86
7.3.3. System utilities:	86
7.3.4. Network utilities:	86
7.4. Accessing CLI	87

Appendix 1. Connections	88
A 1.1. Ethernet Pin outs.....	88
A 1.2. Console and Serial port pin-outs.....	88
A 1.3. Ethernet Wiring Diagram	89
A 1.4. Serial Wiring Diagram	90
A 1.4.1. RS232 Serial Wiring Diagram.....	90
A 1.4.2. RS422/485 Serial Wiring Diagram	91
Appendix 2. Pro Series Configuration files	92
A 2.1. port1.conf	92
A 2.2. filter.conf	92
A 2.3. snmp.conf.....	92
Appendix 3. Well-known port numbers	94
Appendix 4. Guide to the Bios menu program	95
A 4.1. Overview	95
A 4.2. Main menu	95
A 4.3. RTC configuration menu	95
A 4.4. Hardware test menu.....	96
A 4.5. Firmware upgrade menu	99
Appendix 5. Using Pro Series with Serial/IP	101
A 5.1. Pro Series vs. Serial/IP options	101
A 5.2. Connection example - Telnet and SSLv3 encryption.....	101

1. Introduction

1.1. Overview

This document is intended for the HelloDevice Pro Series, PS110/410/810.

The HelloDevice Pro Series is a Universal terminal server (or device server) that makes your legacy serial devices manageable by an industry-standard Ethernet network. Based on open network protocols such as TCP/IP and UDP, it gives you ultimate flexibility to your serial devices.

With the rich broadband network connectivity protocols such as DHCP and Dynamic DNS, you can easily manage legacy serial devices over broadband Internet by using DSL or cable modem connection. The built-in Dynamic DNS protocol of the HelloDevice Pro Series enables you to access the serial devices with their own domain names.

The HelloDevice Pro Series also provides you with full-featured system management functionality of system status display, firmware upgrade, remote reset and system log display by using various ways such as telnet, SSH, serial console port or web.

You can easily configure and administrate the HelloDevice Pro Series, with the full-featured management functions of status monitor, remote reset, error log monitor and firmware upgrade by using Telnet and serial console port under the password protection support.

For critical applications of secure data communication, the HelloDevice Pro Series supports SSLv3 for data encryption. In addition, IP address filtering function is provided for protecting unintentional data streams to be transmitted to the HelloDevice Pro Series.

Typical application areas of the HelloDevice Pro Series are:

- Industrial automation
- Network management
- Retail/Point of sale
- Remote metering
- Remote display
- Building automation
- Security/Access control systems
- General data acquisition application
- Medical application

The HelloDevice Pro Series gives you ideal remote management capability of control, monitoring, diagnosis and data gathering over RS232/422/485 serial devices.

Please note that this manual assumes user knowledge of Internetworking protocols and serial communications.

1.2. Package Check List

- PS110/410/810 external box
- External 110V (or 230V) power supply(PS110/PS410) or power cord(PS810)
- Serial cable kit
- Quick Start Guide
- CD-ROM, including the Serial/IP, HelloDevice Manager and manuals

1.3. Product Specification

	PS110	PS410	PS810
Serial Interface	1-port	4-port	8-port
	Serial speeds 75bps to 230Kbps		
	Flow Control: Hardware RTS/CTS, Software Xon/Xoff		
	RJ45 connector		
	Signals: RS232 Rx, Tx, RTS, CTS, DTR, DSR, DCD, GND RS422 Rx+, Rx-, Tx+, Tx- RS485 Data+, Data-		
	Modem controls: DTR, DSR and DCD		
Network Interface	10/100 Base-Tx Ethernet with RJ45 Ethernet connector		
	Supports static and dynamic IP address		
Protocols	<ul style="list-style-type: none"> - ARP, IP/ICMP, TCP, UDP, Telnet, SSH v2, - SSLv3 - DNS, Dynamic DNS, HTTP, HTTPS, NFS - SMTP with/without Authentication, pop-before SMTP, - DHCP client, NTP, SNMP v1 & v2 		
Security	User ID & Password		
	HTTPS		
	Secure terminal interface: SSH		
	Data Encryption: SSLv3		
	IP address filtering		
Modem emulation	Full support for AT commands		
Management	Web, Telnet, SSH, Serial console port or HelloDevice Manager		
	O/S support: Windows 98/ME/NT/2000/XP		
	System log Automatic email delivery of error log		
	System statistics Full-featured system status display		
	Firmware Stored in Flash memory and upgradeable via telnet or web		
Diagnostic LED	Power Ready (PS810 only) 10/100 Base Link 10/100 Base Act (PS410/PS810 only) Serial Rx/ Tx for each port		
Environmental	Operating temperature: 5°C to 50°C Storage temperature: -40°C to 66°C		
Power	9~30VDC, 0.35A @ 9VDC	9~30VDC, 0.4A @ 9VDC	100 – 240VAC, 0.24A
Dimension L x W x H (mm)	114 x 82 x 26 (mm) 4.48 x 3.22 x 1.02 (in.)	119 x 227 x 27 (mm) 4.68 x 8.94 x 1.06 (in.)	119x 437 x 44 (mm) 4.69 x 17.20 x 1.73(in.)
Weight (kg)	0.300	0.750	1.56
Certification	FCC(A), CE(A), MIC		
Warranty	5-year limited warranty		

1.4. Terminologies and acronyms

This section will define commonly used terms in this manual. These terms are related to Internetworking, and defined in regards to their use with Pro Series.

- **MAC address**

On a local area network or other network, the MAC (Media Access Control) address is the computer's unique hardware number. (On an Ethernet LAN, it is the same as the Ethernet address.)

It is a unique 12-digit hardware number, which is composed of 6-digit OUI (Organization Unique Identifier) number and 6-digit hardware identifier number. The Pro Series has the following MAC address template: 00-01-95-xx-xx-xx. The MAC address can be found on the bottom of the original package.

- **Host**

A user's computer connected to the network

Internet protocol specifications define "host" as any computer that has full two-way access to other computers on the Internet. A host will have a specific "local" or "host number" that, together with the network number, forms its unique IP address.

- **Session**

A series of interactions between two communication end points that occur during the span of a single connection

Typically, one end point requests a connection with another specified end point. If the specified end point replies, and agrees to the connection, the end points then take turns exchanging commands and data ("talking to each other"). The session begins when the connection is established at both ends and terminates when the connection is ended.

- **Client/Server**

Client/server describes the relationship between two computer programs in which one program, the client, makes a service request from another program, the server, which fulfills the request.

A server is a computer program that provides services to other computer programs on one or many computers. The client is the requesting program or user in a client/server relationship. For example, the user of a Web browser is effectively making client requests for pages from servers all over the Web. The browser itself is a client in its relationship with the computer that is getting and returning the requested HTML file. The computer handling the request and sending back the HTML file is a server.

Table 1-1 Acronym Table

ISP	Internet Service Provider
PC	Personal Computer
NIC	Network Interface Card
MAC	Media Access Control
LAN	Local Area Network
UTP	Unshielded Twisted Pair
ADSL	Asymmetric Digital Subscriber Line
ARP	Address Resolution Protocol
IP	Internet Protocol
ICMP	Internet Control Message Protocol
UDP	User Datagram Protocol
TCP	Transmission Control Protocol
DHCP	Dynamic Host Configuration Protocol
SMTP	Simple Mail Transfer Protocol
FTP	File Transfer Protocol
PPP	Point-To-Point Protocol
PPPoE	Point-To-Point Protocol over Ethernet
HTTP	HyperText Transfer Protocol
DNS	Domain Name Service
DDNS	Dynamic Domain Name Service
SNMP	Simple Network Management Protocol
RADIUS	Remote Access for Dial-In User Service
SSH	Secure Shell
NTP	Network Time Protocol
UART	Universal Asynchronous Receiver/Transmitter
Bps	Bits per second (baud rate)
DCE	Data Communications Equipment
DTE	Data Terminal Equipment
CTS	Clear to Send
DSR	Data Set Ready
DTR	Data Terminal Ready
RTS	Request To Send
DCD	Data Carrier Detect

2. Getting Started

This chapter describes how to set up and configure the Pro Series.

- *2.1 Panel Layout* explains the layout of the panel and LED indicators.
- *2.2 Connecting the Hardware* describes how to connect the power, the network, and the equipment to the Pro Series.
- *2.3 Accessing the Web Browser Management Interface* describes how to access the console port using a serial console or a Telnet or Web menu from remote location.

The following items are required to get started.

- One power cable (included in the package)
- One Serial data cable (included in the package)
- One Ethernet cable
- One PC with Network Interface Card (hereafter, NIC) and/or one RS232 serial port.

2.1. Panel Layout

2.1.1. PS110 Panel Layout

The PS110 has four LED indicator lamps for status display. Upper-left lamp indicates the system power-on status. Lower-left lamp indicates the 10/100Base Ethernet Link status. Right two lamps indicate Receive and Transmit of the serial port.

There is a factory reset switch bottom panel of PS110 and the user can use this switch to restore factory default configuration.

There is also a DIP switch located next to the Ethernet connector to set communication type of serial port. (Please refer to Section 4.2.6 and Appendix A for more detail information of serial communication type and its connection)

User can also select console or data mode of serial port using the Data/Console switch located next to the serial port. (Please refer to Section 2.2.5 for more detail information of serial console access)

Table 2-1 LED indicator lamps of the PS 110

Lamps		Function
Status	Power	Turned on to RED if power is supplied
	Ethernet Ready	Turned on to GREEN if system is connected to Ethernet network.
Serial port	Rx	Blinks whenever there is any incoming data stream through the serial port of the PS110
	Tx	Blinks whenever there is any outgoing data stream through the serial port of the PS110

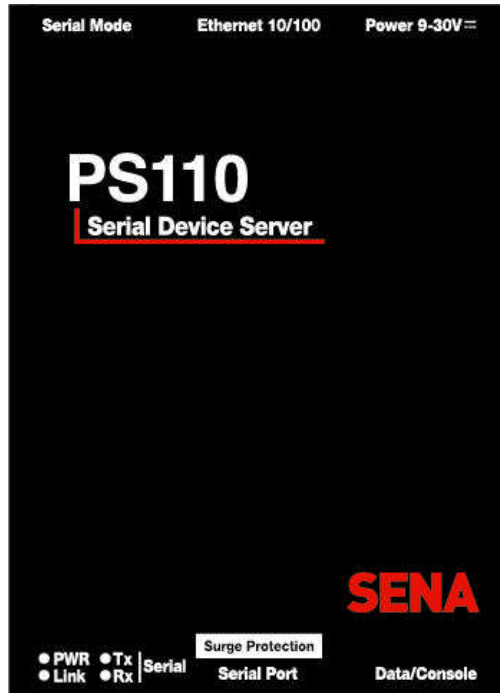

Figure 2-1 The panel layout of the PS110

2.1.2. PS410/810 Panel Layout

The PS410/810 has three groups of LED indicator lamps to display the status, as shown in *Figure 2-2* and *Figure 2-3* (i.e. System, Ethernet and Serial ports). The first two lamps on the left side indicate Power, Ready(PS810 only). The next two lamps are for Ethernet Link and Act. Next lamps indicate Receive and Transmit of the serial port.

Table 2-2 describes the function of each LED indicator lamp.

Table 2-2 LED indicator lamps of the PS410/810

Lamps		Function
System	Power	Turned on if power is supplied
	Ready	Turned on if system is ready to run (PS810 only)
Ethernet	LINK	Turned on if connected to Ethernet network
	Act	Blinks whenever there is any activities such as incoming or outgoing packets through the Pro Series Ethernet port
Serial port	Rx	Blinks whenever there is any incoming data stream through the serial port of the Pro Series
	Tx	Blinks whenever there is any outgoing data stream through the serial port of the Pro Series

There is a factory reset switch near by Serial console port and user can use this switch to restore factory default configuration.

For PS410 there are 4 DIP switches to set communication type of serial port. (Please refer to Section

4.2.6 and Appendix A for more detail information of serial communication type and its connection)

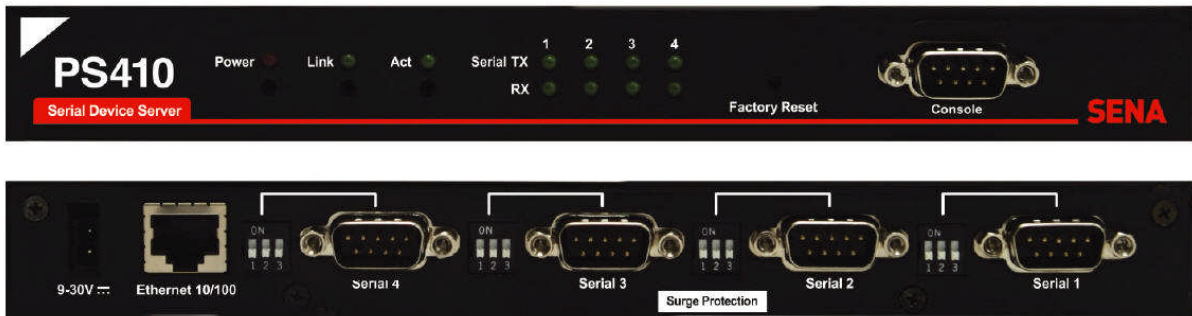

Figure 2-2 The panel layout of the PS410

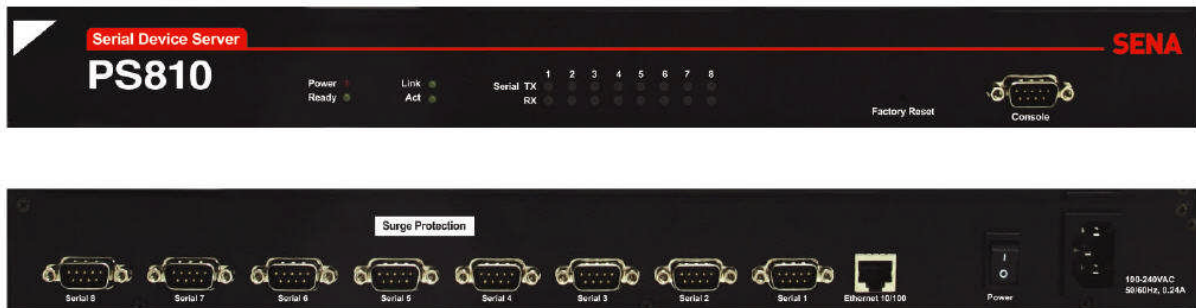

Figure 2-3 The panel layout of the PS810

2.2. Connecting the Hardware

This section describes how to connect the Pro Series to your equipment for initial testing.

- Connect the Pro Series to an Ethernet hub or switch
- Connect the device
- Connect the provided power source to the Pro Series

2.2.1. Connecting to the network

Plug one end of the Ethernet cable to the Pro Series Ethernet port. The other end of the Ethernet cable should be connected to a network port. If the cable is properly connected, the Pro Series will have a valid connection to the Ethernet network. This will be indicated by:

The [Link] lamp will light up green.

The [Act] lamp will blink to indicate incoming/outgoing Ethernet packets

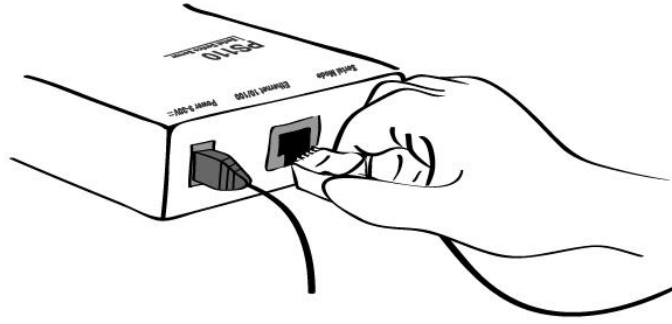

Figure 2-4 Connecting a network cable to the PS110

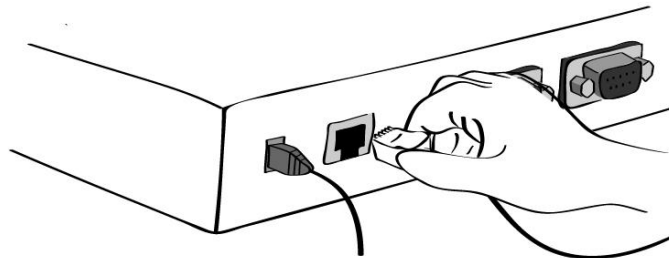

Figure 2-5 Connecting a network cable to the PS410

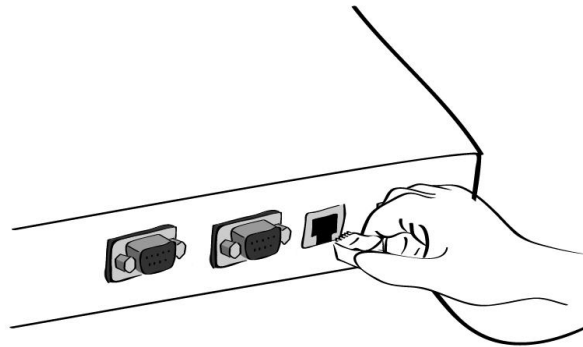

Figure 2-6 Connecting a network cable to the PS810

2.2.2. Connecting to the device

Connect the console cable to the Pro Series serial port. To connect to the console port of the device, the user needs to consider the type of console port provided by the device itself. Please refer to the *Appendix 1 Connections* for details.

Note:

If the configuration of the PS110 through the serial console is required, connect the serial cable to the serial port of user's computer first. And push the Data/Console switch to the Console side. And also please set the position of DIP switch for serial mode to RS-232 mode. Configuration of the PS110 is discussed on Section 2.2.5.

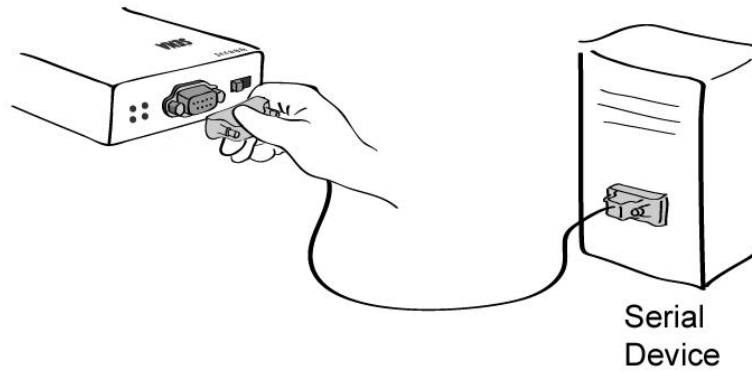

Figure 2-7 Connecting a equipment to the PS110

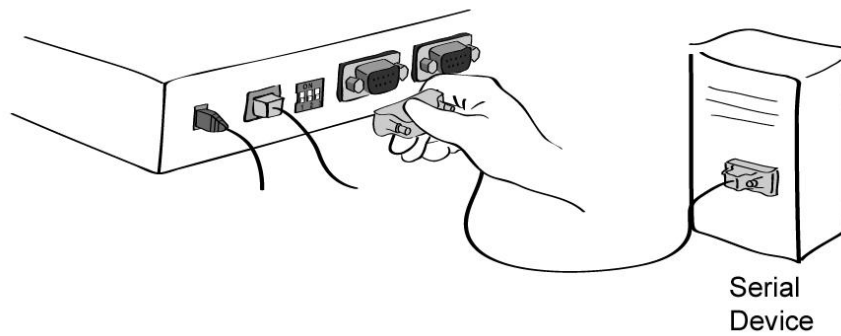

Figure 2-8 Connecting a equipment to the PS410

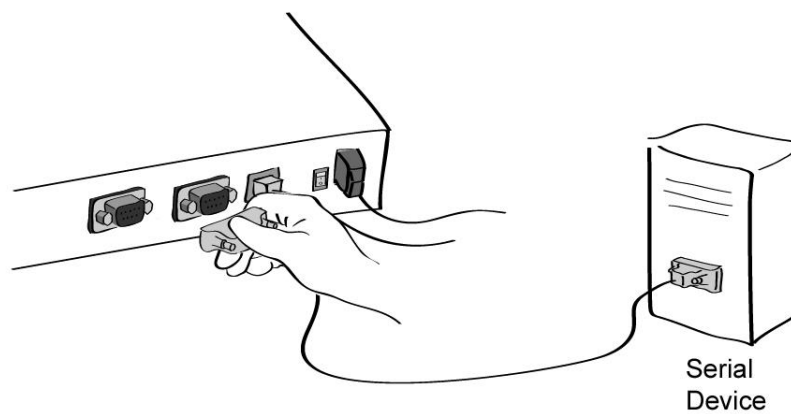

Figure 2-9 Connecting a equipment to PS810(Right)

2.2.3. Connecting the power

Connect the power cable to the Pro Series. If the power is properly supplied, the [Power] lamp will light up solid red.

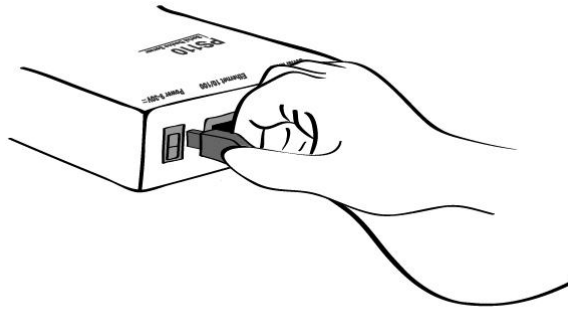

Figure 2-10 Connecting the power to the PS110

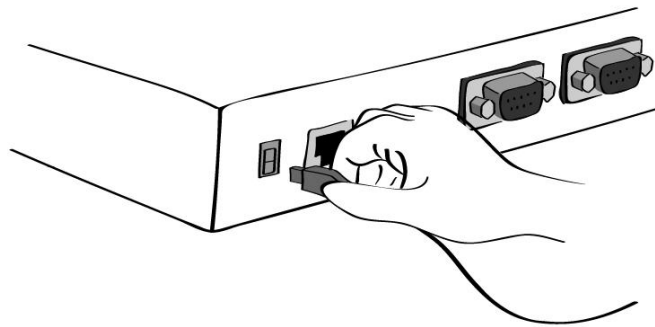

Figure 2-11 Connecting the power to the PS410

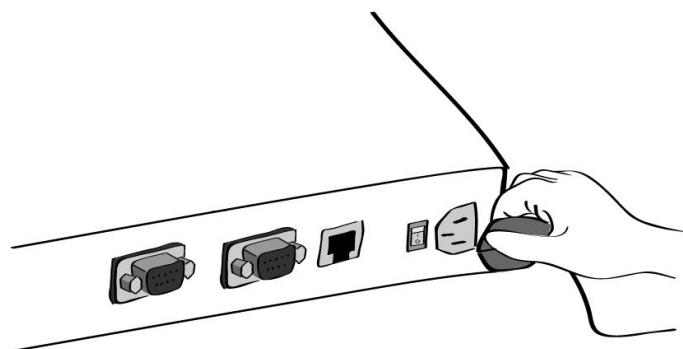

Figure 2-12 Connecting the power to the PS810

2.2.4. Accessing the System Console

There are several ways to access the Pro Series. These methods are dependent on whether the user is located at a local site or a remote site, or whether the user requires a menu-driven interface, graphic menu system or CLI (Command Line Interface).

- **System console:**

Local users can connect directly to the system console port of the Pro Series using the serial console cable.

- **Remote console:**

Remote users who require a menu-driven interface can utilize Telnet (port 23) or SSH (port 22) connections to the Pro Series using Telnet or SSH client.

NOTE : Please note that Pro Series supports only the SSH v2, so user must use the SSH client which is able to support SSH v2.

- **Web:**

Remote users who want to use a web browser to configure the Pro Series can connect to the Pro Series using a conventional web browser, such as Internet Explorer or Netscape Navigator.

The above methods require user authentication by the Pro Series system.

2.2.5. Using the System console

- 1) Connect one end of the console cable to the console port on the Pro Series.
(For PS110, Push the Data/Console switch to the Console side. And also please set the position of DIP switch for serial mode to RS-232 mode. Configuration of DIP switch is discussed on Appendix 1)

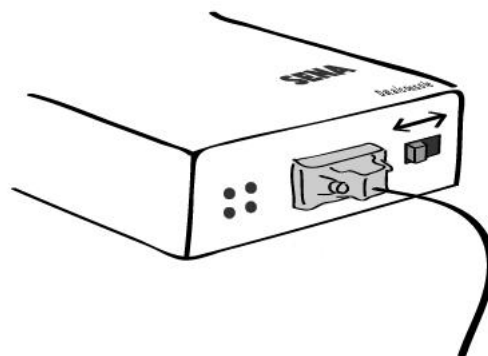

Figure 2-13 Connecting a system console cable to the PS110

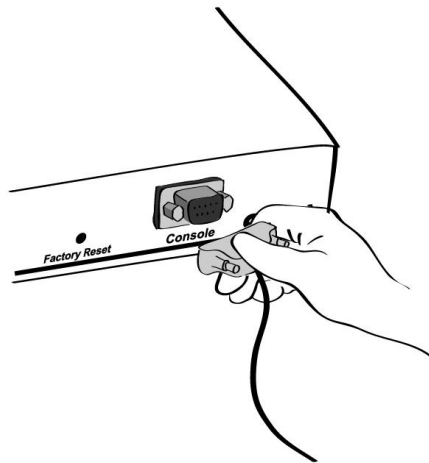

Figure 2-14 Connecting a system console cable to the PS410

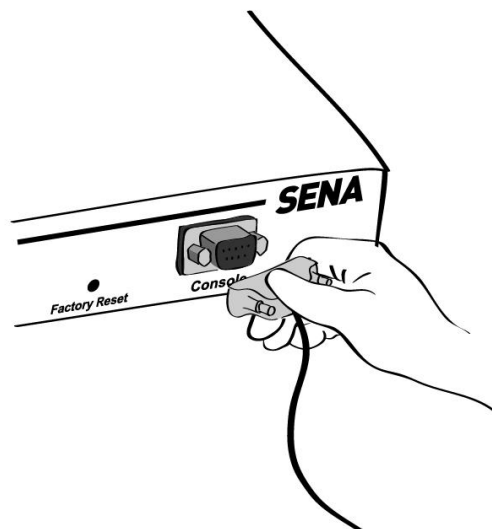

Figure 2-15 Connecting a system console cable to the PS810

- 2) Connect the other end of the cable to the serial port of the user's computer.
- 3) Run a terminal emulator program (i.e. HyperTerminal). Set the serial configuration parameters of the terminal emulation program as follows:
 - **9600 Baud rate**
 - **Data bits 8**
 - **Parity None**
 - **Stop bits 1**
 - **No flow control**
- 4) Press the [ENTER] key.
- 5) Enter your username and password to log into the Pro Series. The factory default user

settings are as follows.

Login: root Password: root

```
ProSeries login: root
Password:
#
```

- 6) After login, user can use various shell commands in the CLI(Command Line interface). For details on the CLI, refer to the chapter 7 *CLI guide*.
- 7) “editconf” command will allow you to enter the text-menu driven interface and the menu screen in *Figure 2-16* is displayed.

```
# editconf

_] / [_____
1. Network configuration
2. Serial port configuration
3. System administration

COMMAND (Display HELP : help)>save
COMMAND (Display HELP : help)>apply
COMMAND (Display HELP : help)>help
_] HELP [_____
[Enter]      refresh
[ESC]       cancel or go to upper
/           go to root
..         go to upper
clear      clear screen
pwd       display path to current menu
save     save current configuration
apply   apply current configuration
help    display this
exit    exit

COMMAND (Display HELP : help)>[Enter]

_] / [_____
1. Network configuration
2. Serial port configuration
3. System administration

COMMAND (Display HELP : help)>
```

Figure 2-16 The main menu screen

From the main menu screen, the users may select a menu item for configuration of the Pro Series parameters by selecting the menu number and pressing the [ENTER] key. In the submenu screen, users can configure the required parameters guided by online comments. All the parameters can be stored into the non-volatile memory space of the Pro Series, but the settings will not be stored until users enter “save” command on the menu. All the configuration change will be effective after entering “apply” command on the menu.

2.2.6. Using Remote console

The IP address of the Pro Series must be known before users can access the Pro Series using the Remote console (see chapter 3 *Network Configuration* for details). The default IP address of Pro Series is **192.168.161.5**.

The Remote console access function can be disabled in the remote host access option (3.5 *IP Filtering* for details).

The following instructions will assist in setting up the Remote Console functionality:

- 1) Run either a Telnet program or a program that supports Telnet functions (i.e. TeraTerm-Pro or HyperTerminal). The target IP address and the port number must match the Pro Series. If required, specify the port number as 23. Type the following command in the command line interface of user's computer.

```
telnet 192.168.161.5
```

Or run a Telnet program with the following parameters:

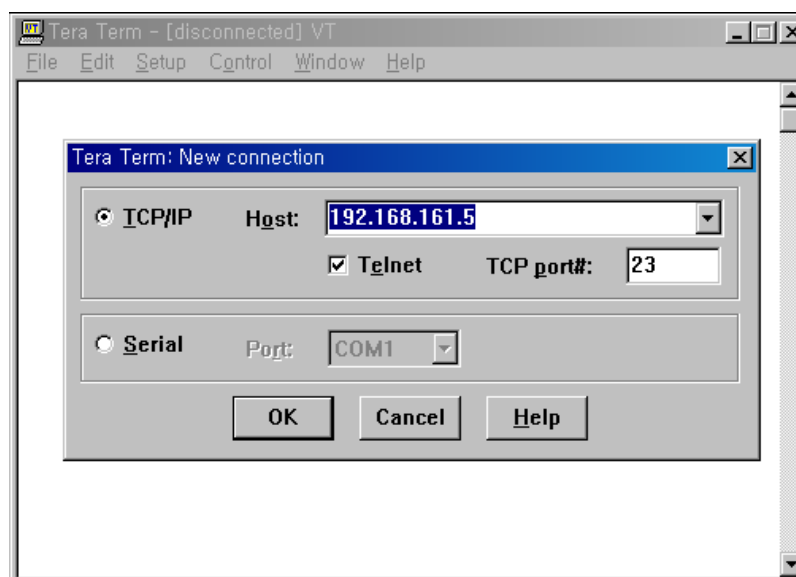

Figure 2-17 Telnet program set up example (TeraTerm Pro)

- 2) The user must log into the Pro Series. Type the user name and password. A factory default settings of the user name and password for CLI login are both **root**.
- 3) After entering correct user name and password, user can see the CLI prompts.

2.3. Accessing the Web Browser Management Interface

The Pro Series supports both HTTP and HTTPS (HTTP over SSL) protocols. The Pro Series also contains its own Web management utility. To access the Pro Series Web management utility, enter the IP address or resolvable hostname of the Pro Series into the web browser's URL/Location field. This will direct the user to the Pro Series login screen. The user must authenticate themselves by logging into they system with a correct user name and password. The factory default settings are:

Login: root Password: root

Note: Before accessing the Pro Series Web management page, the user must check the IP address (or resolvable Hostname) of the Pro Series and Subnet mask settings.

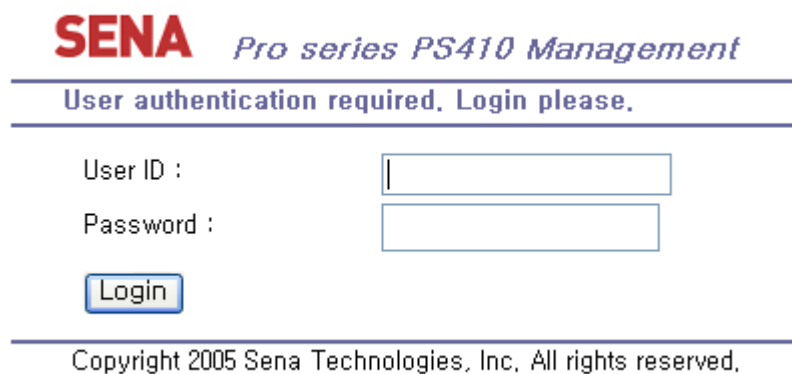

SENA Pro series PS410 Management

User authentication required. Login please.

User ID :

Password :

Copyright 2005 Sena Technologies, Inc. All rights reserved.

Figure 2-18 Login screen of the Pro Series web management

Figure 2-19 shows the configuration homepage of the Pro Series Web management interface. A menu bar is provided on the left side of the screen. The menu bar includes the uppermost configuration menu groups. Selecting an item on the menu bar opens a tree view of all the submenus available under each grouping. Selecting a submenu item will allow the user to modify parameter settings for that item. Every page will allow the user to [Save], [Save & apply] or [Cancel] their actions. After changing the configuration parameter values, the users must select [Save] to save the changed parameter values to the non-volatile memory. To apply all changes made, the user must select [Apply Changes]. This option is available on the bottom of the menu bar. Only when the user selects [Apply changes] will the new parameter values be applied to the Pro Series configuration. The user also can select [Save & apply] to save parameters and apply changes in one step.

If the user does not want to save the new parameter values, the user must opt to [Cancel]. All changes made will be lost and the previous values restored. But the changes that are already saved or applied cannot be canceled.

Network configuration

IP configuration
SNMP configuration
Dynamic DNS configuration
SMTP configuration
IP filtering configuration
SYSLOG configuration
Locating server configuration
NFS configuration
TCP configuration

Serial port configuration

Configuration

System administration

System status
System logging
Device name
Date and time
Change password
User administration
Factory reset
Firmware upgrade

System statistics

Network interfaces
Serial ports
IP
ICMP
TCP
UDP

Apply Changes

Logout

Reboot

System status : /system/sysstatus

System information

Device name : ProSeries
Serial No. : PS410-20060624J0J
F/W Rev. : v1.1.0rc3t7
Current time : 03/02/2000 05:12:04
System logging : Enable
Send system log by email : Disable

IP information

IP mode : Static
IP address : 192.168.4.41
Subnetmask : 255.255.0.0
Gateway : 192.168.1.1
Receive/Transmit errors : 0/268
Primary DNS : 168.126.63.1
Secondary DNS : 168.126.63.2

Copyright 2005 Sena Technologies, Inc. All rights reserved.

Figure 2-19 The Pro Series web management screen

3. Network Configuration

3.1. IP Configuration

The Pro Series requires a valid IP address to operate within the user's network environment. If the IP address is not readily available, contact the system administrator to obtain a valid IP address for the Pro Series. Please note that the Pro Series requires a unique IP address to connect to the user's network.

The users may choose one of three Internet protocols in setting up the Pro Series IP address: i.e.,

- **Static IP**
- **DHCP** (Dynamic Host Configuration Protocol)

The Pro Series is initially defaulted to **STATIC** mode, with a static IP address of **192.168.161.5**. *Table 3-1* shows the configuration parameters for all three IP configurations. *Figure 3-1* shows the actual web-based GUI to change the user's IP configuration.

Table 3-1 IP configuration Parameters

Static IP	IP address
	Subnet mask
	Default gateway
	Primary DNS/ Secondary DNS
DHCP	Primary DNS/ Secondary DNS (Optional)

IP configuration : /network/ip/

IP mode	<input type="text" value="static IP"/>
IP address	<input type="text" value="192.168.222.9"/>
Subnet mask	<input type="text" value="255.255.0.0"/>
Default gateway	<input type="text" value="192.168.1.1"/>
Primary DNS	<input type="text" value="168.126.63.1"/>
Secondary DNS (optional)	<input type="text" value="168.126.63.2"/>

Copyright 2005 Sena Technologies, Inc. All rights reserved.

Figure 3-1 IP Configuration

3.1.1. Using a Static IP Address

When using a **Static IP** address, the user must manually specify all the configuration parameters associated with the IP address of the Pro Series. These include the IP address, the network subnet mask, the gateway computer and the domain name server computers. This section will look at each of these in more detail.

Note: *The Pro Series will attempt to locate all this information every time it is turned on.*

- **IP address**

A Static IP address acts as a “static” or permanent identification number. This number is assigned to a computer to act as its location address on the network. Computers use these IP addresses to identify and talk to each other on a network. Therefore, it is imperative that the selected IP address be both unique and valid in a network environment.

Note: *192.168.1.x will never be assigned by and ISP (Internet Service Provider). IP addresses using this form are considered private. Actual applications of the Pro Series may require access to public network, such as the Internet. If so, a valid public IP address must be assigned to the user’s computer. A public IP address is usually purchased or leased from a local ISP.*

- **Subnet mask**

A subnet represents all the network hosts in one geographic location, such as a building or local area network (LAN). The Pro Series will use the subnet mask setting to verify the origin of all packets. If the desired TCP/IP host specified in the packet is in the same geographic location (on the local network segment) as defined by the subnet mask, the Pro Series will establish a direct connection. If the desired TCP/IP host specified in the packet is not identified as belonging on the local network segment, a connection is established through the given default gateway.

- **Default gateway**

A gateway is a network point that acts as a portal to another network. This point is usually the computer or computers that control traffic within a network or a local ISP (Internet service provider). The Pro Series uses the IP address of the default gateway computer to communicate with hosts outside the local network environment. Refer to the network administrator for a valid gateway IP address.

- **Primary and Secondary DNS**

The DNS (Domain Name System) server is used to locate and translate the correct IP address for a requested web site address. A domain name is the web address (i.e. **www.yahoo.com**) and is

usually easier to remember. The DNS server is the host that can translate such text-based domain names into the numeric IP addresses for a TCP/IP connection.

The IP address of the DNS server must be able to access the host site with the provided domain name. The Pro Series provides the ability to configure the required IP addresses of both the Primary and Secondary DNS servers addresses. (The secondary DNS server is specified for use when the primary DNS server is unavailable.)

3.1.2. Using DHCP

Dynamic Host Configuration Protocol (DHCP) is a communications protocol that lets network administrators manage and automate the assignment of IP addresses centrally in an organization's network. DHCP allows the network administrator the ability to Provide and distribute IP addresses from a central point and automatically send a new IP address when a computer is plugged into a different network location.

When in static IP mode, the IP address must be entered manually at each computer. If a computer is moved to another network location, a new IP address must be assigned. DHCP allows all the parameters, including the IP address, subnet mask, gateway and DNS servers to be automatically configured when the IP address is assigned. DHCP uses a "lease" concept in assigning IP addresses to a computer. It limits the amount of time a given IP address will be valid for a computer. All the parameters required to assign an IP address are automatically configured on the DHCP server side, and each DHCP client computer receives this information when the IP address is provided at its boot-up.

Each time the device is reset, the Pro Series broadcasts a DHCP request over the network. The reply generated by the DHCP server contains the IP address, as well as the subnet mask, gateway address, DNS servers and the "lease" time. The Pro Series immediately places this information in its memory. Once the "lease" expires, the Pro Series will request a renewal of the "lease" time from the DHCP server. If the DHCP server approves the request for renewal, the Pro Series can continue to work with the current IP address. If the DHCP server denies the request for renewal, the Pro Series will start the procedure to request a new IP address from the DHCP server.

Note: *While in DHCP mode, all network-related parameters for the Pro Series are to be configured automatically, including the DNS servers. If the DNS server is not automatically configured, the user may manually configure the settings by entering the primary and secondary DNS IP addresses. To force an automatic configuration of the DNS address, set the primary and secondary DNS IP addresses to 0.0.0.0 (recommended).*

A DHCP sever assigns IP addresses dynamically from an IP address pool, which is managed by the network administrator. This means that the DHCP client, i.e. the Pro Series, receives a different IP

address each time it boots up. The IP address should be reserved on the DHCP server side to assure that the user always knows the newly assigned Pro Series address. In order to reserve the IP address in the DHCP network, the administrator needs the MAC address of the Pro Series found on the label sticker at the bottom of the Pro Series.

3.2. SNMP Configurations

The Pro Series has the SNMP (Simple Network Management Protocol) agent supporting SNMP v1 and v2 protocols. Network managers like NMS or SNMP Browser can exchange information with Pro Series, as well as access required functionality.

SNMP protocols include GET, SET, GET-Next, and TRAPs. With these functions, a manager can be notified of significant events (TRAPs), query a device for more information (GET), and make changes to the device state (SET). SNMPv2 adds a GET-Bulk function for retrieving tables of information and security functions.

With the SNMP configuration panel, the user can configure MIB-II System objects, access control settings and TRAP receiver settings. The manager configured in this menu can perform both information exchange and action control. *Figure 3-2* shows a SNMP configuration screen via a web interface.

SNMP configuration : /network/snmp/

sysContact	<input type="text" value="administrator"/>
sysName	<input type="text" value="Pro410"/>
sysLocation	<input type="text" value="my location"/>
sysService	<input type="text" value="7"/>
PowerOnTrapEnable	<input type="button" value="Disable"/>
AuthTrapEnable	<input type="button" value="Disable"/>
LoginTrapEnable	<input type="button" value="Disable"/>

Configure the access control settings

No.	IP address	Community	Permission
1	<input type="text" value="0.0.0.0"/>	<input type="text" value="public"/>	<input type="button" value="Read Only"/>
2	<input type="text" value="0.0.0.0"/>	<input type="text" value="public"/>	<input type="button" value="Read Only"/>
3	<input type="text" value="0.0.0.0"/>	<input type="text" value="public"/>	<input type="button" value="Read Only"/>
4	<input type="text" value="0.0.0.0"/>	<input type="text" value="public"/>	<input type="button" value="Read Only"/>

Configure the trap receiver settings

No.	IP address	Community	Version
1	<input type="text" value="0.0.0.0"/>	<input type="text" value="public"/>	<input type="button" value="v1"/>
2	<input type="text" value="0.0.0.0"/>	<input type="text" value="public"/>	<input type="button" value="v1"/>
3	<input type="text" value="0.0.0.0"/>	<input type="text" value="public"/>	<input type="button" value="v1"/>
4	<input type="text" value="0.0.0.0"/>	<input type="text" value="public"/>	<input type="button" value="v1"/>

Figure 3-2 SNMP Configuration

3.2.1. MIB-II System objects Configuration

MIB-II System objects configuration sets the System Contact, Name, Location, and Authentication-failure traps used by the SNMP agent of the Pro Series. These settings provide the values used for the MIB-II sysName, sysContact, sysLocation, sysService and enableAuthenTrap.

Brief descriptions of each object are as follows,

- sysContact: Identification of the contact person for the managed system (Pro Series), and a description of how to contact the person.
- sysName: Name used to identify the system. By convention, this is the fully qualified domain name of the node.
- sysLocation: The physical location of the system (e.g., Room 384, Operations Lab, etc.).
- sysService(Read Only) : A series of values, separated by commas, that indicate the set of services that the system provides. By default, Pro Series only supports an Application(7) service level.

- EnablePoweronTraps: Indicates whether the SNMP agent process is permitted to generate power-on traps.
- EnableAuthenTrap: Indicates whether the SNMP agent process is permitted to generate authentication-failure traps. The value of this object overrides any configuration information; as such, it provides a means whereby all authentication-failure traps may be disabled..
- EnableLoginTrap: Indicates whether the SNMP agent process is permitted to generate system login traps for console, telnet and Web access.

If users need support for adding or modifying MIBs, please contact Sena technical support.

For more information about the MIBs and SNMP, see the RFCs 1066, 1067, 1098, 1317, 1318 and 1213.

3.2.2. Access Control Configuration

Access Control defines accessibility of managers to the Pro Series SNMP agent. Only the manager set in this menu can access Pro Series SNMP agent to exchange information and control actions. If there is no specified IP address (all IP address are defaulted to 0.0.0.0), a manager from any host can access the Pro Series SNMP agent.

3.2.3. Trap Receiver Configuration

The Trap receiver defines managers, which can be notified of significant events (TRAP) from the Pro Series SNMP agent.

3.2.4. Management using SNMP

The Pro Series can be managed through the SNMP protocol using NMS (Network Management System) or SNMP Browser. Before using the NMS or SNMP Browser, the user must set the access control configuration properly so that the Pro Series permits host access where the NMS or SNMP Browser is executed. *Figure 3-3* shows a screen shot of a typical SNMP browser with MIB-II OIDs of the Pro Series SNMP agent.

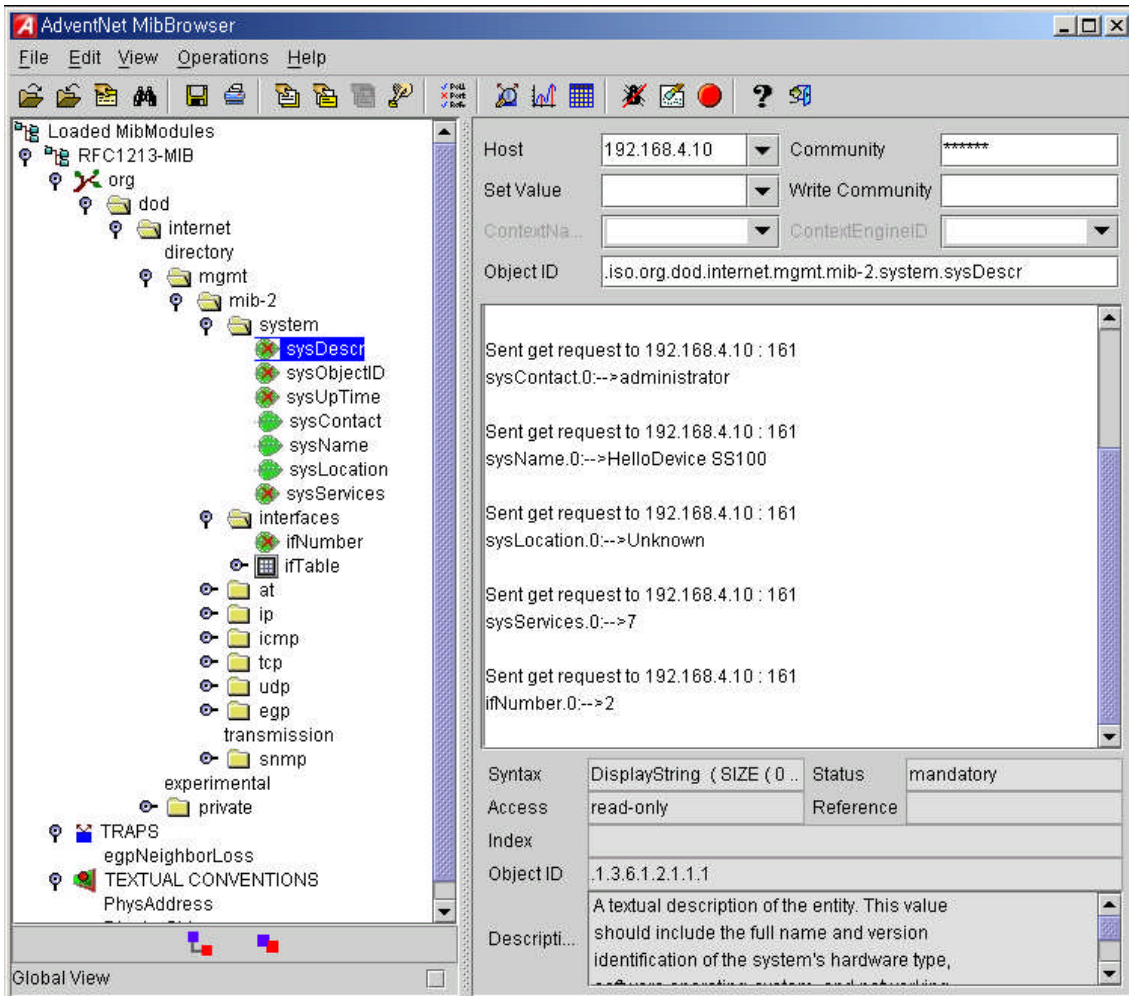

Figure 3-3 Browsing MIB-II OIDs of Pro Series SNMP agent using SNMP Browser (AdventNet MibBrowser)

3.3. Dynamic DNS Configuration

When users connect the Pro Series to a DSL line or use a DHCP configuration, the IP address might be changed whenever it reconnects to the network. It can therefore be very difficult to post all related contacts for each new IP address. In addition, if the administrator only has access through the remote console, there is no way to know if an IP address has changed, or what the new IP address is.

A Dynamic DNS service is provided by various ISPs or organizations to deal with the above issue. By using the Dynamic DNS service, users can access the Pro Series through the hostname registered in the Dynamic DNS Server regardless of any IP address change.

By default, the Pro Series only supports Dynamic DNS service offered at Dynamic DNS Network Services, LLC (www.dyndns.org). Contact Sena technical support for issues regarding other Dynamic DNS service providers.

To use the Dynamic DNS service provided by Dynamic DNS Network Services, the user must set

up an account in their Members' NIC (Network Information Center - <http://members.dyndns.org>). The user may then add a new Dynamic DNS Host link after logging in to their Dynamic DNS Network Services Members NIC.

After enabling the Dynamic DNS service in the Dynamic DNS Configuration menu, the user must enter the registered Domain Name, User Name, and Password. After applying the configuration change, users can access the Pro Series using only the Domain Name.

Figure 3-4 shows the Dynamic DNS configuration web interface.

Dynamic DNS configuration : /network/ddns/

Dynamic DNS	Enable ▾
Domain Name	ps410.dyndns.org
User Name	ps410-user
Password	••••••••
Password(confirm)	••••••••

Save Save & Apply Cancel

Copyright 2005 Sena Technologies, Inc. All rights reserved.

Figure 3-4 Dynamic DNS Configuration

3.4. SMTP Configuration

The Pro Series can send an email notification when the number of system log messages reaches to certain value and/or when an alarm message is created due to an issue with serial port data. The user must configure a valid SMTP server send these automatically generated emails. The Pro Series supports three SMTP server types:

- SMTP without authentication
- SMTP with authentication
- POP-before-SMTP

These examples can be seen in *Figure 3-6*. Required parameters for each SMTP configuration include:

- SMTP server IP address
- SMTP user name
- SMTP user password
- Device mail address

The device mail address specifies the sender's email address for all log and alarm delivery emails.

SMTP servers often check only the sender's host domain name of the email address for validity. Consequently, the email address set for the device can use an arbitrary username with a registered hostname (i.e. *arbitrary_user@yahoo.com* or *anybody@sena.com*).

The SMTP user name and SMTP user password are required when either SMTP with authentication or POP-before-SMTP mode is selected.

The screenshot shows the 'SMTP configuration' page for the path '/network/smtp/'. The configuration is as follows:

SMTP	Enable
SMTP server	smtp.yourcompany.com
Mode	SMTP with authentication
Account Name	admin
Password	•••••
Password(confirm)	•••••
E-Mail	PS410@yourcompany.c

Buttons: Save, Save & Apply, Cancel

Copyright 2005 Sena Technologies, Inc. All rights reserved.

Figure 3-5 SMTP Configurations

The screenshot shows the 'SMTP configuration' page with the 'Mode' dropdown menu open. The configuration is as follows:

SMTP	Enable
SMTP server	smtp.yourcompany.com
Mode	SMTP with authentication
Account Name	POP before SMTP
Password	SMTP without authentication
Password(confirm)	SMTP with authentication
E-Mail	PS410@yourcompany.c

Buttons: Save, Save & Apply, Cancel

Copyright 2005 Sena Technologies, Inc. All rights reserved.

Figure 3-6 SMTP mode selection in SMTP configuration

3.5. IP Filtering

The Pro Series prevents unauthorized access using an IP address based filtering method. The users can allow one of the following scenarios by changing the parameter settings:

- Any host cannot access a specific service of the Pro Series

- Only one host of a specific IP address can access a specific service of the Pro Series
- Hosts on a specific subnet can access a specific service of the Pro Series
- Any host can access a specific service of the Pro Series

The IP filtering feature is intended to control access to Telnet console, SSH console, Web server or each port, which may be enabled or disabled. The factory default of the filtering feature is “All services and ports are accessible from any host”.

The meanings of each parameter in IP filtering configuration are as follows,

- Interface

Apply IP filtering rule to the incoming packet of Pro Series. This is fixed parameter as eth0(Read-Only).
- Option and IP address/mask

Input field to describe a specific range of host on the network. The user may allow a host or a group of hosts to access the Pro Series. The user must then enter the IP address and subnet of access. Any user on a remote host must stay in the specified subnet boundary to access the Pro Series. To allow only a specific host to access the Pro Series, enter the IP address of the specific host and just give 255.255.255.255 for the subnet with Normal option. To allow any hosts to have access to the Pro Series, give 0.0.0.0 for both of the IP address and subnet with Normal option also. Refer to *Table 3-2* for more details.
- Service

Service to which will be applied to the IP filtering rule. User can select one of Telnet, SSH, HTTP, HTTPS or each serial port
- Chain rule

Set the basic rule for the host to access the Pro Series as one of Accept or Drop.

IP filtering configuration : /network/filter/

IP filtering list

No.	Interface	Option	IP address/mask	Service	Chain rule
Nothing					
NEW	eth0	Normal		Telnet	ACCEPT

ADD

Service

Telnet console	Accept all
SSH console	Accept all
HTTP	Accept all
HTTPS	Accept all
Port 1	Accept all
Port 2	Accept all
Port 3	Accept all
Port 4	Accept all

Save Save & Apply Cancel

Figure 3-7 IP filtering Configuration

The Pro Series also provides users with simple configuration way to block a specific service(s) or serial ports from all hosts. If the user should set any service option as “Drop all”, then all access to the service from the network will be blocked.

Service

Telnet console	Drop all
SSH console	Accept all
HTTP	Drop all
HTTPS	Accept all
Port 1	Accept all
Port 2	Accept all
Port 3	Accept all
Port 4	Accept all

Figure 3-8 IP filtering Configuration for each service and serial port

Table 3-2 Input examples of Option and IP address/mask combination

Allowable Hosts	Input format	Option
	IP address/mask	
Any host	0.0.0.0/0.0.0.0	Normal
192.168.1.120	192.168.1.120/255.255.255.255	Normal
Any host except 192.168.1.120	192.168.1.120/255.255.255.255	Invert
192.168.1.1 ~ 192.168.1.254	192.168.1.0/255.255.255.0	Normal
192.168.0.1 ~ 192.168.255.254	192.168.0.0/255.255.0.0	Normal
192.168.1.1 ~ 192.168.1.126	192.168.1.0/255.255.255.128	Normal
192.168.1.129 ~ 192.168.1.254	192.168.1.128/255.255.255.128	Normal
None	0.0.0.0/0.0.0.0	Invert

3.6. SYSLOG server configuration

The Pro Series supports the use of a remote message logging service, SYSLOG service for the system and port data logging. To use the remote SYSLOG service, the user must specify the SYSLOG server's IP address and the facility to be used. *Figure 3-9* shows the SYSLOG server configuration page which is located in the Web interface.

SYSLOG configuration : /network/syslog/

SYSLOG server service ▾

SYSLOG server IP address

SYSLOG facility ▾

Copyright 2005 Sena Technologies, Inc. All rights reserved.

Figure 3-9 SYSLOG server configuration

To receive log messages from the Pro Series, the SYSLOG server must be configured as “remote reception allowed”. If there is a firewall between the Pro Series and the SYSLOG server, there must be a rule that allows all outgoing and incoming UDP packets to travel across the firewall.

The Pro Series supports SYSLOG facilities from local0 to local7. The user can employ these facilities to save messages from the Pro Series separately in the SYSLOG server.

If the SYSLOG service is enabled and the SYSLOG server configuration is properly set up, the user may configure the storage location for the system log or port data log of the Pro Series as SYSLOG server. For more information about the configuration of port/system log storage location, please refer to section, *4.2.8 Port Logging* and *5.2 System Logging*.

3.7. Locating server

3.7.1. Overview

If users want the Pro Series to work as a server (TCP or UDP), the host acting as a client has to know the IP address of the Pro Series. However, under the dynamic IP address environment such as DHCP, arbitrary IP address can be assigned to the Pro Series, which means special consideration is required to access the current IP address of it. To tackle this problem, the Pro Series can be configured to send its IP address information whenever it is assigned a new IP address or periodically to a specific server called locating server. You can operate a specific host as your locating server or you can use your client host as a locating server simultaneously.

No special library or toolkit to implement locating server is provided. You have to implement your own application by using the protocol provided below or contact us.

3.7.2. Locating server configuration

Locating server configuration screen is shown in Figure 3-10. You have to configure locating server IP address, locating server UDP port number and connection time interval as well as to use locating server feature or not. Initially locating server feature is configured as "Disabled".

Locating server configuration : /network/locserver/

Locating server service	Enable <input type="button" value="v"/>
Locating server IP address	<input type="text" value="192.168.0.8"/>
Port	<input type="text" value="9000"/>
Locating server Interval (second)	<input type="text" value="30"/>

Figure 3-10 Locating server configuration

3.7.3. Locating server communication protocol

When the Pro Series sends its IP address information to the locating server, data format will be as follows:

Description	Magic Cookie	Data(0)	Data(1)	...	Data(n)
Bytes	4	Variable	Variable		Variable
Value	F1-AA-AA-BC				

Data(n) format

Description	Data ID	Length	Data
Bytes	1	1	Variable
Value	1~6	Variable	Variable

Data ID

ID	Description	Length
1	Device name	var
2	Model name	var
3	Serial number	var
4	MAC address	6
5	IP address	4
6	Local ports*	1 or 4 or 8

Note:

Local ports: Each 2 byte data represent current local port setting of the corresponding serial port. Local ports data length of PS110 should be 2 bytes, while 8 bytes and 16 bytes for PS410 and PS810 respectively. Configured local TCP (or UDP) port numbers for each serial port are filled in the serial port number order base, (i.e. TCP or UDP port number for serial port 1 first). If serial port is disabled, the local port number of that serial port is regarded as 0.

Example of the PS110:

If port number = 7001 (1B59h), Local ports data = 1Bh, 59h

If serial port is disabled, Local port data = 00h, 00h

Example of the PS410:

Port1 = 7001 (1B59h), Port2 = 7010 (1B62h), Port3 = Disable, Port4 = 7004(1B5Ch)

Local ports data = 1Bh, 59h, 1Bh, 62h, 00h, 00h, 1Bh, 5Ch

3.8. NFS server configuration

The Pro Series supports NFS (**Network File System**) service for system or port data logging functions. To use this service, the user must specify the IP address of a NFS server and the mounting path on the NFS server. *Figure 3-11* displays the NFS server configuration page located in the web configuration interface..

NFS configuration : /network/nfs/

NFS server service	Enable ▾
NFS server IP address	192.168.1.1
Mounting path on NFS server	/
NFS Timeout (sec, 5-3600)	5
NFS mount retrying interval (sec, 5-3600)	5

Copyright 2004 Sena Technologies, Inc. All rights reserved.

Figure 3-11 NFS server configuration

To store the Pro Series log data to the NFS server, the NFS server must be configured as “read and write allowed”. If there is a firewall between the Pro Series and the NFS server, there must be a rule that allows all outgoing and incoming packets to travel across the firewall.

If the NFS service is enabled and the NFS server configuration is properly set up, the user may configure the storage location for the system log or port data log of the Pro Series. If there is a firewall between the Pro Series and the SYSLOG server, there must be a rule that allows all outgoing and incoming UDP packets to travel across the Pro Series as the NFS server. For more information about the configuration of the port/system log storage location, please refer to section, *4.2.8 Port Logging* and *5.2 System Logging*.

3.9. TCP service configuration

If a TCP session is established between two hosts, the connection should be closed (normally or abnormally) by either of the hosts to prevent the lock-up of the corresponding TCP port. To prevent this type of lock-up situation, the Pro Series provides a TCP “keep-alive” feature. The Pro Series will send packets back and forth through the network periodically to confirm that the network exists. The corresponding TCP session is closed automatically if there’s no response from the remote host.

To use the TCP “keep-alive” feature with the Pro Series, the users should configure three parameters as follows:

- **TCP keep-alive time:**
This represents the time interval between the last data transmission and keep-alive packet submissions by the Pro Series. These “keep-alive” messages are sent to the remote host to confirm that the session is still open. The default time value is 15 sec.
- **TCP “keep-alive” probes:**
This represents how many “keep-alive” probes will be sent to the remote host, until it decides that

the connection is dead. Multiplied with the “TCP ‘keep-alive’ intervals”, this gives the time that a link is forced to close after a “keep-alive” packet has been sent for the first time. The default is 3 times

- **TCP keep-alive intervals:**

This represents the waiting period until “keep-alive” packet is retransmitted.

The default value is 5 seconds.

By default, the Pro Series will send the keep-alive packets 3 times with 5 seconds interval after 15 seconds have elapsed since the time when there’s no data transmitted back and forth.

The screenshot shows a configuration window titled "TCP configuration : /network/tcp/". It contains three input fields: "TCP keepalive time" with the value "15", "TCP keepalive probes" with the value "3", and "TCP keepalive intervals" with the value "5". Below the fields are three buttons: "Save", "Save & Apply", and "Cancel".

TCP keepalive time	15
TCP keepalive probes	3
TCP keepalive intervals	5

Copyright 2005 Sena Technologies, Inc. All rights reserved.

Figure 3-12 TCP keep-alive configuration

4. Serial Port Configuration

4.1. Overview

The serial port configuration capability allows the user to configure the host mode of each port, serial communication parameters, cryptography, port logging parameters and other related parameters.

The serial port's host mode can be set as any of the following:

- TCP :**
 The Pro Series operates as a TCP server and client. If the connection is not established, it accepts all incoming connections from any registered remote hosts and connects to the registered remote hosts if there is any data from the serial devices. Otherwise, it will send data back and forth. In summary, the Pro Series will work as if it is virtually connected to the remote host.
- UDP :**
 The UDP mode operation is similar to that of TCP mode except that it is based on UDP protocol.
- Modem emulation :**
 Select this mode when the serial device becomes ready to support modem AT commands or users want to perform the session control by using AT commands. Only TCP session is supported.

With the **port-logging** feature while in console server mode, the data sent through the serial port is transferred to **MEMORY** or **NFS server's storage**. The user can also define keywords for each serial port that will trigger an email or SNMP trap notification. This will enable the user to monitor the data from the attached device.

Using **MEMORY** to store data will result in loss of all information when the Pro Series is turned off. Use the **NFS server** to preserve the serial port log data.

The serial ports can be configured individually or all at once. *Table 4-1* summarizes the configuration parameters related to the serial port configuration.

Table 4-1 Serial port configuration parameters

All serial ports setting Or Individual serial port setting #1~#8(1/4)	Port Enable/Disable		
	Port title		
	Host mode	TCP	Port number
			User authentication
			Telnet support
			Max allowed connection
			Cyclic connection
			Inactivity timeout (0 for unlimited)
	UDP	Port number	
		Max allowed connection	

			Inactivity timeout (0 for unlimited)	
			Accept unlisted	
			Send unlisted	
			Modem emulation	
	Remote host¹	Add or Edit a remote host ² Host IP address Host port Backup host IP address Backup host port		
		Remove a remote host		
	Cryptography³	SSLv3		
		Baud rate		
		Data bits		
		Parity		
		Stop bits		
		Flow control		
		Inter-character timeout (ms)		
		DTR behavior		
		DSR behavior		
	Modem	Enable/Disable modem		
		Modem init-string		
		DCD behavior		
		Automatic release modem connection		
	Port logging	Enable/Disable Port logging		
		Port log storage location		
		Port log buffer size		
		Display port log		
	Port event handling	Enable/Disable port event handling		
		Notification interval		
		Email notification	Enable/Disable Email notification	
			Subject of Email	
			Recipient's Email address	
SNMP notification		Enable/Disable SNMP notification		
		Subject of SNMP trap		
		SNMP trap receiver's IP address		
		SNMP trap community		
		SNMP trap version		
Add/Edit an event keyword Event keyword Email notification SNMP trap notification Port command				
Remove a keyword				

Figure 4-1 shows the web-based serial port configuration screen. This serial port configuration main screen summarizes port information. In this summary page, user can find which host mode, local port number and serial port parameters are currently configured.

User can configure port parameters by clicking number or title of corresponding serial port.

¹ TCP/UDP mode only.

² A backup host and port are used when connection to main host is failed

³ TCP mode only

Serial port configuration : /serial/

No.	Title	Mode	Port#	Serial-Settings		
1	Port #1	TCP	7001	RS_485	230400N 81	Hardware
2	Port #2	ME	7002	RS_232	9600 N 81	None
3	Port #3	UDP	7003	RS_422	2400 N 81	None
4	Port #4	----	-----	-	-	- - - - -

Copyright 2005 Sena Technologies, Inc. All rights reserved.

Figure 4-1 Serial port configuration main screen

4.2. Serial Port Configuration

Individual Port Configurations of the Pro Series are classified into eight groups:

1. Port enable/disable
2. Port title
3. Host mode
4. Cryptography
5. Serial port parameters
6. Modem configuration
7. Port logging
8. Port event handling

4.2.1. Port Enable/Disable

Each serial port can be enabled or disabled. If a serial port is disabled, users cannot access the serial port. Figure 4-2 shows the serial port enable/disable screen.

Serial port configuration - 1 : /serial/*1/

Enable/Disable this port	Enable ▾
Port title	Port #1
Host mode configuration	
Serial port parameters	
Port logging configuration	
Port event handling configuration	
Copy port configuration	

Save Save & Apply Cancel

Figure 4-2 Serial port enable/disable

4.2.2. Port Title

Users can enter descriptive information for each port based on the device attached to it. This can include the device type, vendor, and/or location.

The screenshot shows a configuration window titled "Serial port configuration - 1 : /serial/*1/". It features a dropdown menu for "Enable/Disable this port" set to "Enable", and a text input field for "Port title" containing "Port #1". Below these are five menu items: "Host mode configuration", "Serial port parameters", "Port logging configuration", "Port event handling configuration", and "Copy port configuration". At the bottom are three buttons: "Save", "Save & Apply", and "Cancel".

Figure 4-3 Port title configuration

4.2.3. Host Mode Configuration

The Pro Series operating mode is called the “host mode.” Three host modes are available: **TCP mode**, **UDP mode**, **Modem emulation mode**.

TCP mode

The Pro Series works as both TCP server and client. This mode works for most applications, since it will transfer the data either from serial port or from TCP port. If there is no connection established on a TCP port, the TCP port accepts a connection request from any registered remote hosts and relays the transmitted data to the coupled serial port. If there is any data from the serial port, it connects to the registered remote hosts and redirects the data.

UDP mode

The UDP mode operation is similar to that of TCP mode except that it utilizes UDP protocol.

Modem emulation mode

Select this mode when the serial device already supports modem AT commands or users want to perform the session control by using AT commands. Only TCP session is supported.

Figure 4-4 shows the main workspace screen for the host mode configuration.

The screenshot displays the 'Host mode configuration' window for the path '/serial/*1/hostmode/'. The window is divided into several sections:

- Enable/Disable this port:** A dropdown menu set to 'Enable'.
- Port title:** A text input field containing 'Port #1'.
- Host mode configuration:** A section containing:
 - Host mode:** A dropdown menu set to 'TCP'.
 - Port number (1024-65535, 0 for only outgoing connections):** A text input field containing '7001'.
 - User authentication:** A dropdown menu set to 'Disable'.
 - Telnet support:** A dropdown menu set to 'Enable'.
 - Max. allowed connection (1-8):** A text input field containing '8'.
 - Cyclic connection (sec, 0 : disable):** A text input field containing '0'.
 - Inactivity timeout (sec, 0 : unlimited):** A text input field containing '0'.
- Remote host:** A section with a text input field.
- Cryptography configuration:** A section with a text input field.
- Modem configuration:** A section with a text input field.
- Serial port parameters:** A section with a text input field.
- Port logging configuration:** A section with a text input field.
- Port event handling configuration:** A section with a text input field.
- Copy port configuration:** A section with a text input field.

At the bottom of the window, there are three buttons: 'Save', 'Save & Apply', and 'Cancel'.

Figure 4-4 Host mode configuration (TCP mode)

4.2.3.1. TCP mode

For easier understanding of TCP modes, a simplified **State Transition Diagram** is often used. And to help users understand the diagram, the TCP state of the Pro Series is briefly described as follows.

- [Listen]

It represents "a waiting for a connection request from any registered remote host". It is a default start-up mode when it is set as TCP mode.

- [Closed]

It means "no connection state". If the data transfer between a remote host and the Pro Series is completed, the state is changed to this state as a result that either of the remote host or the Pro Series sent a disconnection request. After this, the state is automatically changed to [Listen] mode.

- [Sync-Received]

The state is changed from [Listen] to [Sync-Received] if one of the remote hosts has sent a connection request. If the Pro Series accepts the request, the state is changed into [Established].

- [Sync-Sent]

If the Pro Series has sent a connection request to a remote host, the state is changed from [Closed] to [Sync-Sent]. This state is maintained until the remote host accepts the connection request.

- [Established]

It represents “an open connection”. If one of the hosts, the remote host or the Pro Series, accepts a connection request from the other, the connection is opened and state is changed into [Established].

- [Data]

When it is in [Established] state, data from a host will be transferred to the other one. For easier understanding of the TCP session operation, we called the state as [Data] state when actual data transfer is performed. Actually, the [Data] mode is a part of [Established] state as is described in the RFC 793 [Transmission Control Protocol]. This is a normal state for the data transfer phase of the connection.

The Pro Series works as either TCP server or client according to the situation. This will be the typical mode for most applications, since it will transfer the data either from serial port or from TCP port. The default TCP state is [Listen] which is the same as that of *TCP server mode*.

1) Typical State Transition

[Listen] --> [Sync-Received] --> [Established] --> [Data] --> [Closed] --> [Listen]

Or

[Listen] --> [Sync-Sent] --> [Established] --> [Data] --> [Closed] --> [Listen]

The initial state is [Listen]. If there are data coming from the serial port, it will connect to the remote host as a TCP client and then transfer data through the TCP port. If there is incoming connection request from the remote host, it will accept the connection as a TCP server, and then transfer data through the serial port. Thus, users can assume that the Pro Series is always connected to the specified remote host.

2) Operations

Serial data transfer

Whenever the serial device sends data through the serial port of the Pro Series, data will be accumulated on the serial port buffer of the Pro Series. If the buffer is full or the time gap reaches the *inter-character timeout* (See *Options* in section 4.4 for details on *inter-character timeout*), the Pro Series connect to the registered remote host(s). If a TCP session has not been established yet. If the Pro Series succeeds in connecting to the remote host, the data in the serial port buffer will be transferred to the host. Otherwise, all the data stored in the buffer will be cleared.

Session disconnection

The connected session will be disconnected when the remote host sends disconnection request or when no data transfer activity is found through the serial port for certain amount of time, which is "*Inactivity timeout*" (See *Options* in section 4.4 for details on *Inactivity timeout*). All the data remained in the serial port buffer will be cleared when it is disconnected.

Connection request from remote host

All the incoming TCP connection requests will be rejected in *TCP client* mode.

3) Parameters

TCP listening port

This is the TCP port number through which a remote host can connect a TCP session, and, send and receive data. Incoming connection request(s) to the ports other than *TCP Listening Port* will be rejected. The Pro Series does restrict the port number from 1024 to 65535 and if it is set as 0 only outgoing connection is permitted. (TCP server mode)

User authentication

If the User authentication option is enabled, the user can access the port after entering the correct user ID and password. Please refer to the section 5.8 User administration for details of user management.

Telnet protocol

In TCP mode, Pro Series supports Telnet Com Port Control Option (RFC2217 compliant) so that user can control serial parameters like baud rate, data bits and flow control option using his local RFC2217-compliant Telnet client program. (Please refer to section 4.2.6 *Serial port parameters* for more detail information about serial parameters)

Usually this option is used with the RFC2217-compliant COM port redirector so that user can control parameters of serial ports of Pro Series using his serial port application program.

For this purpose, SENA OEM version of Serial/IP from Tactical Software, LLC is bundled with Pro Series. Please refer to documentations of Serial/IP for more detail information about using the COM port redirector. (Please refer to section Appendix 5 Using Pro Series with Serial/IP for more detail information)

Max. allowed connection

The Pro Series supports up to 8 multiple connections from external host(s) to the serial port. If there are remote host connections by the *remote host list configuration* already, possible number of connection will be reduced (Max. allowed connection - remote host(s) connected already). For example, if user set *Max. allowed connection* as 8 and if there are 3 connections from Pro Series to remote hosts, which are configured in the remote host list, then maximum number of connection from external hosts to a serial port will be reduced to 5. For more detailed information

for remote host list configuration, please refer to 4.2.4 Remote host configuration section.

Cyclic Connection

If *Cyclic Connection* function is enabled, the Pro Series will make an attempt to connect to the user-defined remote host(s) at a given interval even if there's no incoming serial data from the device connected to that serial port. If there is data on the remote host(s) to be sent to serial device, it can be transferred to the serial device via Pro Series' serial port after the connection is established. Eventually, users can monitor the serial device periodically by making the remote host send the serial command to the Pro Series whenever it is connected to the remote host. This option is useful when users need to gather the device information periodically even if the serial device does not send its data periodically. Figure 4-5 shows the State Transition Diagram of the session operations in *TCP* mode.

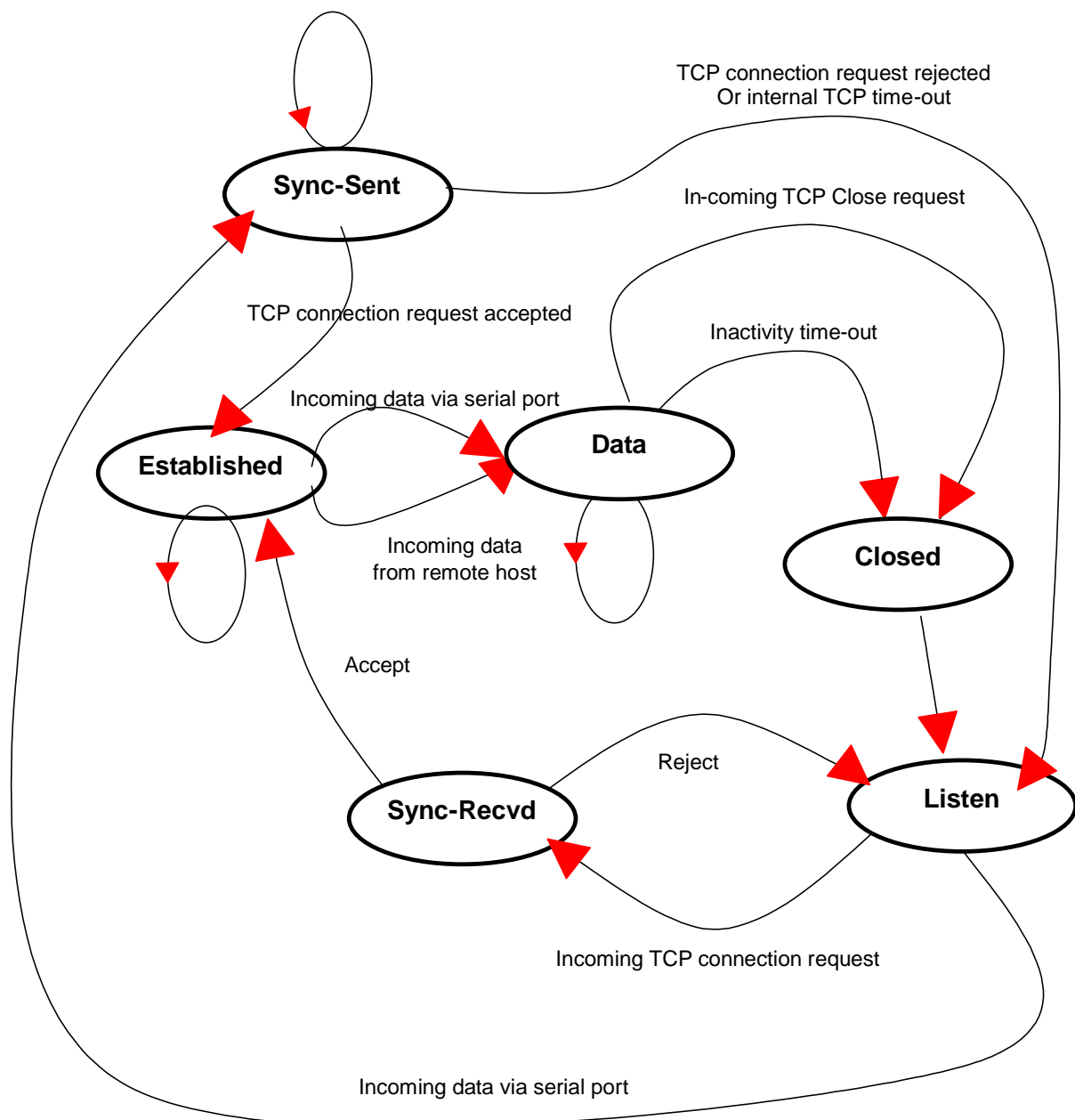

Figure 4-5 State Transition Diagram of TCP mode

Inactivity Timeout

When *Inactivity Timeout* function is enabled, connection between remote host(s) and Pro Series will be closed automatically if there is no data transmission during the value which is set in *Inactivity Timeout* configuration.

4.2.3.2. UDP mode

The UDP mode operation is similar to that of *TCP* mode except that it is based on UDP protocol and only one pre-defined remote host is able to communicate with the Pro Series. Users do not have to

configure *cyclic connection*, since UDP is a connectionless protocol.

Host mode configuration : /serial/*1/hostmode/

Enable/Disable this port	Enable ▾
Port title	Port #1
Host mode configuration	
Host mode	UDP ▾
Port number (1024-65535, 0 for only outgoing connections)	7001
Max. allowed connection (1-8)	8
Inactivity timeout (sec, 10-3600)	100
Accept unlisted	Yes ▾
Send unlisted	Yes ▾
Remote host	
Serial port parameters	
Port logging configuration	
Port event handling configuration	
Copy port configuration	

Save Save & Apply Cancel

Figure 4-6 Host mode configuration (UDP mode)

1) Operations

If a remote host sends a UDP datagram to the one of UDP *Local port* of the Pro Series, Pro Series first checks whether it is from one of the hosts configured on *remote host configuration*. If the remote host is one of the hosts configured on *remote host configuration*, then Pro Series transfers the data through the serial port. Otherwise, the Pro Series discards the incoming UDP datagram. But user can force Pro Series accept all incoming UDP datagram regardless *remote host configuration* by setting *Accept UDP datagram from unlisted remote host* parameter as 'Yes'. If there is any incoming data from the serial port, the Pro Series transfers the data to the remote host defined on *remote host configuration*. If the remote port is not opened, the Pro Series will not transfer the data.

2) Parameters

UDP receiving port

The concept is the same as *TCP listening port*. See **TCP mode parameters** in the section 4.2.3.1 for details.

Max. allowed connection

The concept is the same as that of TCP communication. See **TCP mode parameters** in the section 4.2.3.1 for details.

Accept UDP datagram from unlisted remote host

If *Accept unlisted* (Accept UDP datagram from unlisted remote host) function is set as 'No', Pro Series will accept only incoming UDP datagram from the remote host(s) configured on *remote host configuration*. On the contrary if *Accept unlisted* function is set as 'Yes', Pro Series will accept all incoming UDP datagram regardless *remote host configuration*.

Send to recent unlisted remote host

If *Send unlisted* (Send to recent unlisted remote host) function is set as 'Yes', Pro Series sends data to the remote host, which has connected Pro Series recently. Recent unlisted remote host is a remote host, which has accessed a corresponding serial port of Pro Series but is not configured on *remote host configuration*. Surely, Pro Series also send data to the hosts, which are configured on *remote host configuration*. If *Send unlisted* function is set as 'No', Pro Series sends data only to the host(s) which are configured on *remote host configuration*. Pro Series maintains a recent unlisted remote host during the *Inactivity Timeout*.

Inactivity Timeout

In UDP mode, *Inactivity Timeout* is used in maintaining recent unlisted remote host. If there is no data transmission between unlisted remote host and serial port of Pro Series during *Inactivity Timeout*, Pro Series will not send data from a serial port to the recent unlisted remote host again. Namely, *Inactivity Timeout* in UDP mode is the time maintained recent unlisted remote host list by Pro Series.

NOTE: If user set *Inactivity Timeout* as 0 in UDP mode, Pro Series does not allow any new connection from/to remote host if the number of current remote host exceeds *Max. allowed connection*.

4.2.3.3. Modem emulation mode

1) Operations

In modem emulation mode, the serial port process acts as if it is a modem attached to the serial device. It accepts AT modem commands and answers to them, as modems would do. It also handles the modem signals correctly. Modem emulation mode is useful in the following cases.

- There already exists a modem attached to the users' serial device.

If users' serial device already has a modem for phone-line connection, it can be just replaced by the Pro Series for Ethernet connection. What users need to do is to use an IP address (or domain name) and port number instead of phone number as a parameter of ATA/ATDT commands.

- It is required to send serial data to the multiple remote hosts.

If the serial device should send data to the multiple hosts, modem emulation mode is required. For example, the first data from the serial device can be sent to the first data acquisition server and the second to the second server. What user device has to do is to change the IP address (or domain name) and port number parameters whenever the device sends ATD(T) XXX command.

By using the modem emulation mode of the Pro Series, users can have their serial device connected to the Ethernet network easily, which is cheaper than using phone line modem. *Table 4-2* is a summarized AT command table which is supported by the Pro Series. *Figure 4-7* shows the typical case of the serial port command flow when ATDA command is used to connect to the Ethernet network.

Table 4-2 AT commands supported in the Pro Series

Command	Internal Operation	Response ⁴ (Verbose Code)
+++	Return to command input mode	None
ATD(T) [remote IP or domain name]:[remote port] [CR][LF] or ATD(T) [remote IP][remote port] [CR][LF]	Set TCP mode as TCP client mode. And then, try to connect to the specified remote host. e.g. atdt192.168.1.9:1002 e.g. atdt1921680010091002 Connect to IP address, 192.168.1.9, port 1002 (Port Number is permitted from 1 to 65534) e.g. atdtps.sena.com:1002 Connect to domain address ps.sena.com, port 1002	If successful, CONNECT [CR][LF] If failure in connection, NO CARRIER [CR][LF] If other errors, ERROR [CR][LF]
AT or ATZ [CR][LF]	Initialize TCP socket and serial port	If successful, OK [CR][LF] If failure, ERROR [CR][LF] If successful, OK [CR][LF] If failure, ERROR [CR][LF]
ATA/ [CR][LF]	Repeat last command	
ATA [Local port number] [CR][LF]	Set TCP mode as TCP server mode. And then, set TCP state as [Listen]. -. If the command parameter, Local port number is not specified, the TCP session parameter, Local Port is used instead.	
ATEn [CR][LF]	E, E0: Disable echo E1: Enable echo	
ATOn [CR][LF]	O, O0: Turn to data mode	
ATQn [CR][LF]	Q, Q0: Response display on (default) Q1: Response display off	
ATVn [CR][LF]	V, V0: Response = <numeric code> [CR][LF] V1 (default): Response = <verbose code> [CR][LF]	
AT&Dn [CR][LF]	D, D0: ignore DTR(PC) signal D2(default): disconnect TCP session	
AT&Fn [CR][LF]	F, F0, F1: Restore default modem settings	
AT&Kn [CR][LF]	K, K0: No flow control K3: RTS/CTS flow control (default) K4: Xon/Xoff (if supported)	

⁴ If *Echo* mode is enabled, the command will be sent back first. And then, corresponding response will be sent. If disabled, only response will be sent.

AT&Sn [CR][LF]	S, S0: DSR(PC) always high S1: DSR(PC) shows TCP connection	
ATHn [CR][LF]	H, H0: Disconnect current TCP connection All the data will be cleared H1: Keep the current TCP connection	OK [CR][LF]
ATIn [CR][LF]	I, I0 : display "Sena Technologies, Inc." I3 : display model number Others : display "OK"	<=
AT\Tn [CR][LF]	Set inactivity timer to n minutes \T, \T0: inactivity timer disabled (default)	OK [CR][LF]
ATBn, ATCn, ATLn, ATMn, ATNn, ATP, ATT, ATYn, AT%Cn, AT%En, AT&Bn, AT&Gn, AT&In, AT&Qn, AT&V, ATMn, ATAn, AT\Bn, AT\Nn, ATXn	none	OK [CR][LF]
ATS?, ATSn=x, AT&Cn, AT&Wn, AT&Zn=x	none	ERROR [CR][LF]
ATFn [CR][LF]	None	If n=1 OK [CR][LF] If others, ERROR [CR][LF]
ATWn	None	If n=0 OK [CR][LF] If others, ERROR [CR][LF]

Table 4-3 AT commands Response Code

Verbose Code (After "ATV1" command executed)	Non-Verbose Code(Numeric Code) (After "ATV0" command executed)	Description
OK	0	Command executed
CONNECT	1	Modem connected to line
RING	2	A ring signal has been detected
NO CARRIER	3	Modem lost carrier signal
ERROR	4	Invalid command

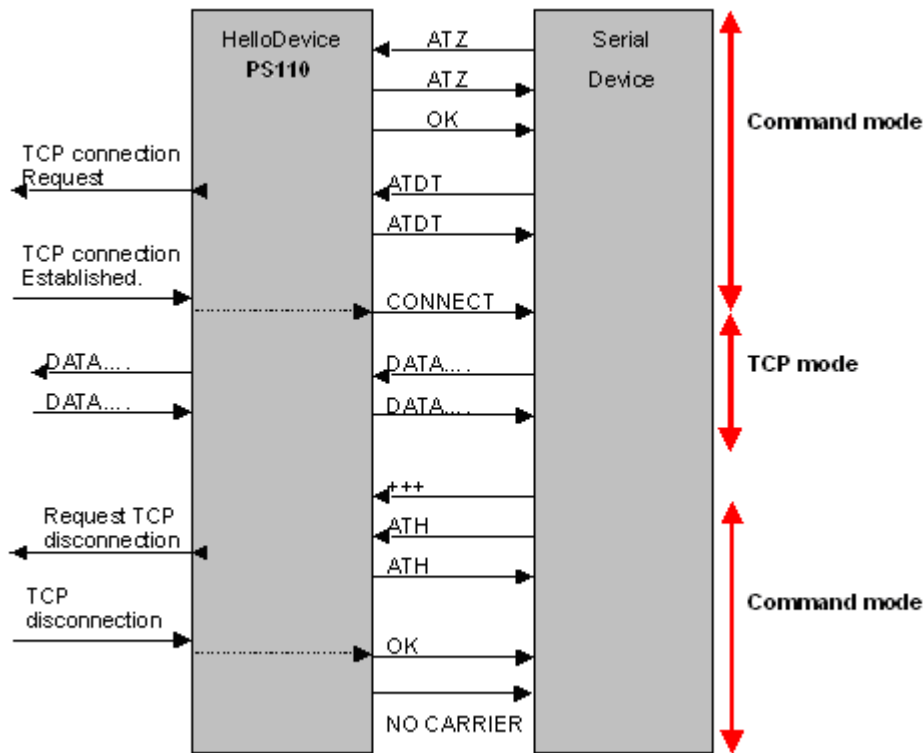

Figure 4-7 Typical case of command/data flow of modem emulation mode

In modem emulation mode, user can also set specific phone number to host address/port mapping table. If user set the phone number to host address/port mapping table as shown on Figure 4-8, Pro Series will try to connect to port 7001 of 192.168.1.1 host by the 'atdt5737772' command in modem emulation mode.

2) Parameters

Phone number to host address mapping table

In modem emulation mode, user can set a specific phone number to host address/port mapping table. If user set the phone number to host address/port mapping table as shown on Figure 4-8, Pro Series will try to connect to port 6001 of 192.168.0.100 host by the 'atdt25737772' command in modem emulation mode.

CONNECT string in non-verbose mode (ATV0) and CONNECT string in verbose mode (ATV1)

In modem emulation mode, the Pro Series responds to the AT command according to result code in Table 4-3 by default. But there are some cases that device requires different form of response code for remote host connection. For example, when the Pro Series connects the remote host, it replies "1"(if ATV0 command is set) or "CONNECT" (if ATV1 command is set) result code by

default. But if user needs “12” (if ATV0 command is set) or “CONNECT 9600” (if ATV1 command is set) response for this case, he can get the required result after setting CONNECT strings as shown on Figure 4-8.

Phone number to host address mapping table : /serial/*1/hostmode/phonetoipable/

Enable/Disable this port

Port title

Host mode configuration

Host mode

Phone number to host address mapping table

No.	Phone number	Host address	Host port number	
1	<input type="text" value="25737772"/>	<input type="text" value="192.168.0.100"/>	<input type="text" value="6001"/>	<input type="button" value="REMOVE"/>
NEW	<input type="text" value="8225718283"/>	<input type="text" value="192.168.0.101"/>	<input type="text" value="6001"/>	<input type="button" value="ADD"/>

CONNECT string in non-verbose mode(ATV0)

CONNECT string in verbose mode(ATV1)

Cryptography configuration

Serial port parameters

Port logging configuration

Port event handling configuration

Copy port configuration

Figure 4-8 Host mode configuration (Modem emulation mode)

4.2.4. Remote host configuration

Remote host configuration is the list of hosts that will receive data from serial port of Pro Series when there is data transmission from the serial port of the Pro Series.

In TCP mode, user can also configure secondary remote host (Backup host) that will receive data from serial port if Pro Series fails to connect to primary remote host. If a connection to the primary remote host can be made, Pro Series dose not send data to secondary remote host until connection to primary remote host failed. And the maximum possible number of primary remote host is limited up to 4 remote connections.

In UDP mode, user can only configure a primary remote host because there is no way for Pro Series to check status of primary remote host, so secondary remote host is meaningless.

The maximum number of remote host is limited up to 4 in the Pro Series. *Figure 4-9* shows Remote host configuration pages of the Web UI. (TCP mode)

User can also set any effective domain name as *Host IP address* in the Remote host configuration.

Remote host : /serial/+1/hostmode/remotehost/

Enable/Disable this port ▾

Port title

Host mode configuration

Host mode ▾

Port number (1024-65535, 0 for only outgoing connections)

User authentication ▾

Telnet support ▾

Max. allowed connection (1-8)

Cyclic connection (sec, 0 : disable)

Inactivity timeout (sec, 0 : unlimited)

Remote host

No.	Host address	Host port number	Backup host address	Backup port	
1	<input type="text" value="192.168.100.1"/>	<input type="text" value="7001"/>	<input type="text" value="192.168.100.1"/>	<input type="text" value="7002"/>	<input type="button" value="REMOVE"/>
2	<input type="text" value="192.168.100.1"/>	<input type="text" value="7001"/>	<input type="text" value="192.168.100.2"/>	<input type="text" value="7001"/>	<input type="button" value="REMOVE"/>
3	<input type="text" value="remote.domain.com"/>	<input type="text" value="6001"/>	<input type="text" value="remote.domain.com"/>	<input type="text" value="6002"/>	<input type="button" value="REMOVE"/>
NEW	<input type="text" value="192.168.100.3"/>	<input type="text" value="6001"/>	<input type="text" value="remote.domain.com"/>	<input type="text" value="6001"/>	<input type="button" value="ADD"/>

Cryptography configuration

Modem configuration

Serial port parameters

Port logging configuration

Port event handling configuration

Copy port configuration

Figure 4-9 Remote host configuration

4.2.5. Cryptography configuration

The Pro Series supports encrypted sessions for only the TCP mode including modem emulation mode (not UDP mode).

Cryptography configuration : /serial/*1/hostmode/ssl/

Enable/Disable this port

Port title

Host mode configuration

Host mode

Port number (1024-65535, 0 for only outgoing connections)

User authentication

Telnet support

Max, allowed connection (1-8)

Cyclic connection (sec, 0 : disable)

Inactivity timeout (sec, 0 : unlimited)

Remote host

Cryptography configuration

Encryption method

Modem configuration

Serial port parameters

Port logging configuration

Port event handling configuration

Copy port configuration

Figure 4-10 Cryptography configuration

4.2.5.1. Secure Sockets Layer(SSL) cryptography method

By setting the cryptography method as SSL, the Pro Series can communicate with another device supporting SSLv3 cryptography method during encrypted sessions.

SSL was developed by Netscape for use between clients and servers. SSL layers on top of any transport protocol and can run under application protocols such as HTTP. SSL aims to be secure, fast, and adaptable to other Web protocols. SSL provides data security for applications that communicate across networks. SSL is a transport-layer security protocol layered between application protocols and TCP/IP.

To initiate SSL sessions, exchange of messages called the SSL handshake is required between two devices (Server and Client). The SSL protocol uses a combination of public-key and symmetric key encryption. Symmetric key encryption is much faster than public-key encryption, but public-key encryption provides better authentication techniques. The handshake allows the server to authenticate itself to the client using public-key techniques, and then allows the client and the server to cooperate in the creation of symmetric keys used for rapid encryption, decryption, and tamper detection during the session that follows. The details of handshake process step involved can be summarized as follows:

1. The client sends the server the client's SSL version number, cipher settings, randomly generated data, and other information the server needs to communicate with the client using SSL.
2. The server sends the client the server's SSL version number, cipher settings, randomly generated data, and other information the client needs to communicate with the server over SSL. The server also sends its own certificate and, if the client is requesting a server resource that requires client authentication, requests the client's certificate.
3. The client uses some of the information sent by the server to authenticate the server. If the server cannot be authenticated, the user is warned of the problem and informed that an encrypted and authenticated connection cannot be established. If the server can be successfully authenticated, the client goes on to next step.
4. Using all data generated in the handshake so far, the client (with the cooperation of the server, depending on the cipher being used) creates the premaster secret for the session, encrypts it with the server's public-key (obtained from the server's certificate, sent in step 2), and sends the encrypted premaster secret to the server. SSL differ in the way this "shared" master secret is created
5. If the server has requested client authentication (an optional step in the handshake), the client also signs another piece of data that is unique to this handshake and known by both the client and server. In this case the client sends both the signed data and the client's own certificate to the server along with the encrypted premaster secret.
6. If the server has requested client authentication, the server attempts to authenticate the client. If the client cannot be authenticated, the session is terminated. if the client can be successfully authenticated, the server uses its private key to decrypt the premaster secret, then performs a series of steps (which the client also performs, starting from the same premaster secret) to generate the master secret.
7. Both the client and the server use the master secret to generate the session keys, which are symmetric keys used to encrypt and decrypt information exchanged during the SSL/TLS session and to verify its integrity--that is, to detect any changes in the data between the time it was sent and the time it is received over the SSL connection.
8. The client sends a message to the server informing it that future messages from the client will be encrypted with the session key. It then sends a separate (encrypted) message indicating that the client portion of the handshake is finished.
9. The server sends a message to the client informing it that future messages from the server will be encrypted with the session key. It then sends a separate (encrypted) message indicating that the server portion of the handshake is finished.
10. The SSL handshake is now complete, and the SSL session has begun. The client and the server use the session keys to encrypt and decrypt the data they send to each other and to validate its integrity.

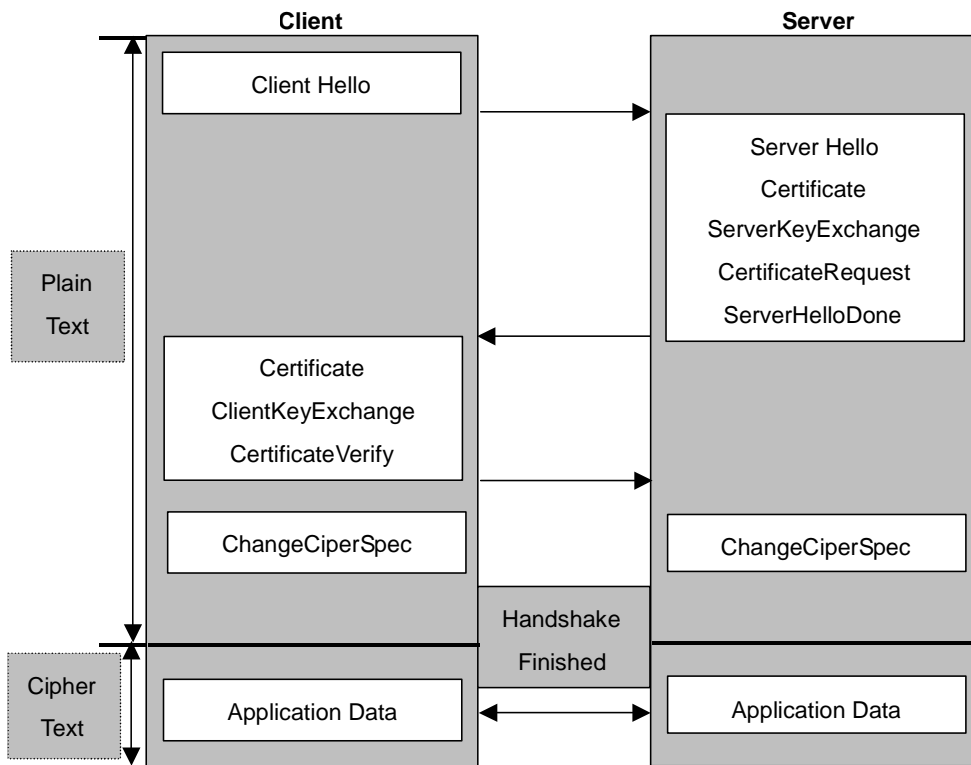

Figure 4-11 Typical SSL Handshake Process

The Pro Series can act as a SSL server or as a SSL client depending on status of TCP mode. If TCP connection with SSL is initiated from remote host first, Pro Series acts as a SSL server during the SSL handshake process. On the contrary, if TCP connection with SSL is initiated from serial port of Pro Series first, Pro Series acts as a SSL client during the SSL handshake process.

4.2.5.2. RC4 cryptography method

In RC4 cryptography mode, the Pro Series encrypt and decrypt all TCP streams using a Key string. The Pro Series can communicate with another device or another Pro Series that supports RC4 cryptography mode with same Key string.

For the sample application programs of SSL/RC4 cryptography method, please contact the Sena Technical support.

Cryptography configuration : /serial/*1/hostmode/ssl/

Enable/Disable this port Enable

Port title

Host mode configuration

Host mode TCP

Port number (1024-65535, 0 for only outgoing connections)

User authentication Disable

Telnet support Disable

Max, allowed connection (1-8)

Cyclic connection (sec, 0 : disable)

Inactivity timeout (sec, 0 : unlimited)

Remote host

Cryptography configuration

Encryption method RC4

Key string

Modem configuration

Serial port parameters

Port logging configuration

Port event handling configuration

Copy port configuration

Figure 4-12 RC4 Cryptography configuration

4.2.6. Serial port parameters

To connect the serial device to the Pro Series serial port, the serial port parameters of the Pro Series should match exactly to that of the serial device attached. The serial port parameters are required to match this serial communication. The parameters required for the serial communication are: UART type, baud rate, data bits, parity, stop bits, flow control DTR/DSR behavior and inter-character timeout.

- **UART type**

First of all, the Pro Series and the serial device must agree on the serial communication type, which is one of RS232 mode, RS422(RS485 full) mode or RS485 half mode. User can set the serial communication type by using DIP switch near by serial port in case of PS110/410. To change the serial communication type, change the position of each DIP switch as shown on Figure 4-13. For PS810, user can change the serial communication type of each serial port using configuration menu as shown on Figure 4-16.

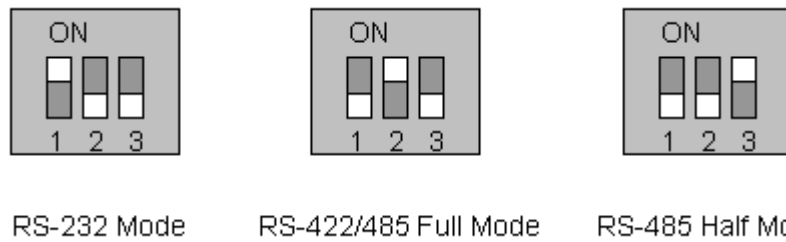

Figure 4-13 Serial communication type and DIP switch configuration. (PS110/410)

For more information about pin out of serial port and wiring diagram, please refer to *Appendix 1 Connections* section.

NOTE :

1. Please turn off the power of the Pro Series device before changing the position of DIP switch in case of PS110/410. Changing the position of DIP switch while the power is on may cause damage to the device.
(If the DIP switches are set incorrectly the PS110/410 will display “Invalid” for the UART type on the UI as shown on *Figure 4-14*, which will hinder communications to the serial port.)
2. In case of PS810, UART type can be changed by software through configuration only. So PS810 does not have a DIP switch for changing UART type.

Serial port configuration : /serial/

No.	Title	Mode	Port#	Serial-Settings
1	Port #1	TCP	7001	RS_485 9600 N 8 1 None
2	Port #2	TCP	7002	RS_485 9600 N 8 1 None
3	Port #3	TCP	7003	RS_232 9600 N 8 1 None
4	Port #4	ME	7004	Invalid 9600 N 8 1 None

Figure 4-14 Invalid UART type settings displayed on the Serial port configuration main screen

- **Baud rate**

The valid baud rate for the Pro Series is as follows:

75, 150, 200, 300, 600, 1200, 2400, 4800, 9600, 14400, 19200, 38400, 57600, 115200, and 230400

The factory default setting is 9600.

- **Data bits**

Data bits can be between 7 bits and 8 bits. The factory default setting is 8 bits.

- **Parity**
Parity can be **none**, **even** or **odd**. The factory default setting is none.
- **Stop bits**
Stop bits can be between 1 bit and 2 bits. The factory default setting is 1 bit.

Serial port parameters : /serial/*1/parameter/

Enable/Disable this port	Enable <input type="button" value="v"/>
Port title	Port #1 <input type="text"/>
Host mode configuration	
Serial port parameters	
UART type	RS_485
Baudrate	9600 <input type="button" value="v"/>
Data bit	8 bits <input type="button" value="v"/>
Stop bit	1 bit <input type="button" value="v"/>
Parity bit	None <input type="button" value="v"/>
Flowcontrol	None <input type="button" value="v"/>
Inter character time-out (0-10000 msec)	0 <input type="text"/>
DTR option	Always HIGH <input type="button" value="v"/>
DSR behavior	None <input type="button" value="v"/>
Port logging configuration	
Port event handling configuration	
Copy port configuration	

Figure 4-15 Serial parameter configuration (PS110/410)

Serial port parameters : /serial/*1/parameter/

Enable/Disable this port Enable

Port title

Host mode configuration

Serial port parameters

UART type RS-485

Baudrate

- RS-232
- RS-422
- RS-485

Data bit

Stop bit 1 bit

Parity bit None

Flowcontrol None

Inter character time-out (0-10000 msec)

DTR option Always HIGH

DSR behavior None

Port logging configuration

Port event handling configuration

Copy port configuration

Figure 4-16 Serial parameter configuration (PS810)

- **Flow control**

The factory default setting of the flow control is *None*. Software Flow Control using XON/XOFF and hardware flow control using RTS/CTS are supported by the Pro Series.

Software flow control method controls data communication flow by sending special characters XON/XOFF (0x11/0x13) between two connected devices. And hardware flow control method controls data communication flow by sending signals back and forth between two connected devices.

Note:

Flow control is supported only in RS232 and RS422 mode. RS485 mode does not support any kind of flow control method.

- **DTR/DSR behavior**

Purpose of the DTR/DSR pin is to emulate modem signal control or to control TCP connection state by using serial port signal. The DTR is a write-only output signal, whereas the DSR is a read-only input signal in the Pro Series.

The DTR option can be set to one of three types: *always high*, *always low* or *high when TCP/UDP is opened*. If the DTR behavior is set to *high when TCP/UDP is opened*, the state of the

DTR pin will be maintained high if the TCP/UDP connection is established.

The DSR input behavior can be set to one of two types: *none or allow TCP/UDP connection only by high*. If user sets the DSR input behavior as *Allow TCP/UDP connection only by HIGH*, TCP connection to remote host from Pro Series is made only when the DSR status is changed from low to high. And TCP connection to remote host is disconnected when the DSR status is changed from high to low. And also Pro Series accepts TCP connection from the remote host only when the DSR status is high. In case of UDP mode, Pro Series receives UDP data from the remote host only when the DSR status is high. But In modem emulation mode, the connection to the remote host will be disconnected when the DSR status is changed from high to low regardless of the value of DSR behavior.

Serial device connected to Pro Series can control TCP/UDP connection of Pro Series by controlling DTR signal of it.

Note:

1. DTR/DSR behavior configuration will not be effective when the modem is enabled.
2. DTR/DSR behavior does not effective in RS422 and RS485 mode.

- **Inter-character timeout**

This parameter defines the interval the Pro Series fetches the overall serial data from its internal buffer. If there is an incoming data through the serial port, the Pro Series stores data into the internal buffer. The Pro Series transfers data stored in the buffer via TCP/IP, only if the internal buffer is full or if the inter-character time interval reaches the time specified in the *inter-character timeout* setting. If *inter-character timeout* is set as 0, then data stored in the internal buffer will be transferred immediately without any delay.

Optimal inter-character timeout would be different according to your application but at least it must be larger than one character interval within specified baud rate. For example, assume that the serial port is set to 1200 bps, 8 Data bits, 1 stop bit, and no parity. In this case, the total number of bits to send a character is 10 bits and the time required to transfer one character is

$$10 \text{ (bits)} / 1200 \text{ (bits/s)} * 1000 \text{ (ms/s)} = 8.3 \text{ ms.}$$

Therefore, you have to set *inter-character timeout* to be larger than 8.3 ms. The *inter-character timeout* is specified in milliseconds.

4.2.7. Modem configuration

The Pro Series supports direct modem connection to the serial port. When user wants to connect to a modem on its serial port, he must configure Modem init-string and DCD behavior on the modem

configuration page. The Pro Series supports modem connection only when host mode is set as *TCP mode*.

- **Enable/Disable modem**

By enabling this menu, user can attach a modem directly to the serial port of Pro Series. If this parameter is enabled, Pro Series considers this port will be used for modem use exclusively.

- **Modem init-string**

User can specify modem initialization string for his modem in *Modem init-string* parameter. When a serial port is set to modem mode by setting *Enable/Disable modem* parameter as Enabled, Pro Series sends modem initialization string to the serial port whenever rising edge of DTR pin is detected or parameter related with serial port configuration is changed.

- **DCD behavior**

If *DCD behavior* is set as *Allow TCP connection only by HIGH*, Pro Series permits a connection from the remote host only when the DCD status of serial port is high. This feature is useful when user want to use a serial port only for dial-in modem mode. In this case, if there is no connection through modem already, Pro Series will not permit a TCP side connection.

- **Automatic release modem connection**

If *Automatic release modem connection* is set as *Enable*, modem connection will be closed by Pro Series if all TCP connections are closed. If this option is set as *Disable*, modem connection will not be closed by Pro Series even if all TCP connections are closed. Please note that actual phone line connection will be closed if one of modems closes connection. That is, this option can be used for Pro Series to allow disconnection of a modem connection by itself when all TCP connections are closed.

If user wants to use dial-out function, he should set *DCD behavior* as *None* because he must be able to access modem connected to a serial port to send dial out command to the modem first.

Modem configuration : /serial/*1/hostmode/modem/

Enable/Disable this port

Port title

Host mode configuration

Host mode

Port number (1024-65535, 0 for only outgoing connections)

User authentication

Telnet support

Max. allowed connection (1-8)

Cyclic connection (sec, 0 : disable)

Inactivity timeout (sec, 0 : unlimited)

Remote host

Cryptography configuration

Modem configuration

Enable/Disable modem

Modem init-string

DCD behavior

Automatic release modem connection

Serial port parameters

Port logging configuration

Port event handling configuration

Copy port configuration

Figure 4-17 Modem configuration

4.2.8. Port Logging

With the port logging feature, the data sent through the serial port is stored to MEMORY or a mounting point on an NFS server.

- **Enable/disable port logging**

This parameter defines whether to enable or disable the port-logging feature. The factory default setting is [disabled].

- **Port log storage location**

The port log data can be stored to the Pro Series' internal memory or the mounting point on an NFS server. If the internal memory is used to store port log data, the port log data will be cleared when the Pro Series is turned off. To preserve the serial port log data, set the storage location to be the NFS server. To do this, the user must configure the NFS server in advance. Please refer to

the section 3.8 NFS server configuration for details of NFS server configuration.

- **Port log buffer size**

This parameter defines the maximum amount of port log data to be logged. When using internal memory to store the log data, the total size of the port buffer cannot exceed 10 Kbytes.

When using an NFS server to store log data, the maximum port buffer size is unlimited. The user should configure the NFS server to ensure that the port logging system works properly.

Port logging configuration : /serial/*1/log/

Enable/Disable this port Enable ▾

Port title

Host mode configuration

Serial port parameters

Port logging configuration

Enable/Disable port logging Enable ▾

Port log storage location RAM disk (10 Kbyte) ▾

Port log view

Port event handling configuration

Copy port configuration

Save Save & Apply Cancel

Figure 4-18 Port logging configuration

4.2.9. Port event handling configurations

The Pro Series provides a user for a means of monitoring or reacting to data from serial device attached to a serial port of it through *Port event handling* configuration. Namely, user can define keywords for each serial port that will trigger the email/SNMP notification or command sent to the serial port directly on *Port event handling* configuration. This will enable the user to monitor the data from the attached device or to manage/control a device attached serial port directly when pre-defined keywords are detected. Also, the status of the connection between the Pro Series and the serial device and the status of the TCP connection between the Pro Series and remote hosts could be monitored and managed as well.

Each reaction can be configured individually upon each event. Reaction can be an email delivery, SNMP trap sending, command sending or either combination of all reactions.

- **Port event handling**

If the user wants to enable *port event handling* feature, set *Port event handling* as enable. This is a global parameter so if this feature is disabled, the Pro Series does not take any actions on port

events.

- **Notification interval**

To prevent Pro Series from being trapped in handling port event, there is a *Notification interval* parameter. Pro Series will send notification email or SNMP trap every *Notification interval* even it detects predefined keyword within *Notification interval*. The smaller value of this parameter will result in immediate response for predefined keyword and heavy usage of system resources. The largest value accepted by user is recommended to prevent system resource usage minimization.

NOTE: The port command in keyword response is not affected by this parameter. Port command will be sent immediately when the corresponding keyword is detected.

- **Email notification**

This parameter enables or disables Email notification feature of the Pro Series. When Pro Series sends Email notification, it uses the SMTP server configured in SMTP server configuration. If the SMTP server is not configured correctly or disabled, Email feature will be disabled. For details of SMTP server configurations and descriptions, please refer to section 3.4 *SMTP Configuration*.

- **Subject of Email**

This parameter set the subject of Email that will be sent by Pro Series when pre-defined keyword is detected.

- **Recipient's Email address**

This parameter set mail recipient who will receive notification mail when pre-defined keyword is detected.

- **SNMP trap notification**

This parameter enables or disables SNMP trap notification feature of Pro Series.

- **Subject of SNMP trap**

This parameter set the subject of SNMP trap that will be sent by Pro Series when pre-defined keyword is detected.

Event keywords : /serial/*1/event/port_event_keyword/

Enable/Disable this port Enable ▾

Port title

Host mode configuration

Serial port parameters

Port logging configuration

Port event handling configuration

Enable/Disable port event handling Enable ▾

Enable/Disable E-mail notification Enable ▾

Subject of E-mail

Recipient's E-mail address

Enable/Disable SNMP notification Enable ▾

Subject of SNMP trap

SNMP trap receiver's IP address

SNMP trap community

SNMP trap version v1 ▾

Notification interval

Event keywords

No.	Event keyword	E-mail notification	SNMP trap notification	Port command	
1	<input type="text" value="keyword"/>	Disable ▾	Disable ▾	<input type="text" value="reaction"/>	REMOVE
NEW	<input type="text"/>	Disable ▾	Disable ▾	<input type="text"/>	ADD

Copy port configuration

Figure 4-19 Port event-handling configurations

- **SNMP trap receiver's IP address**
 This parameter sets the IP address of SNMP trap receiver that will receive SNMP trap notification when pre-defined keyword is detected.

- **SNMP trap community**
 This parameter sets a community that will be included in SNMP trap message when pre-defined keyword is detected.

- **SNMP trap version**
 This parameter sets a version of SNMP trap, which will be sent when pre-defined keyword is detected.

Event keywords

The user can assign event keywords so that the Pro Series takes actions such as sending e-mail notification, sending SNMP trap notification or sending pre-defined command to a serial port if the keyword is detected at the serial port.

- **Event keyword**

User can specify any words, which he/she wants to set as a keyword.

- **Email notification**

User can select enable or disable for the Email notification action on keyword selected.

- **SNMP trap notification**

User can select enable or disable for the SNMP trap notification action on keyword selected.

- **Port command**

Pro Series supports direct reaction to a device attached to serial port when pre-defined keyword is detected. User can specify command or string, which will be sent to a serial port on this menu.

4.2.10. Copy port configuration

User can copy port configuration of one port to another. There are two methods in copying port configuration. One is "Copy current port configuration to" specified ports and another is "Copy current port configuration from" specified port.

NOTE:

Port title, TCP port number and UDP port number are not copied by this function.

Copy port configuration : /serial/*1/copy_port_config

Copy current port configuration to

Port 1 Port 2 Port 3 Port 4

Copy current port configuration from

Port 1 Port 2 Port 3 Port 4

Copy Copy & Apply Reset

그림 4-20 Copy port configuration

5. System Administration

The Pro Series displays the system status and the log data via a Status Display Screen. This screen is used for management purposes. System status data includes the model name, serial number, firmware version and the network configuration of the Pro Series. The Pro Series can also be configured to deliver log data automatically via email to a specified recipient with the system-logging feature.

The users can configure the Pro Series' device name, date and time settings, and reload factory default settings in this menu group. The users can also upgrade the firmware of the Pro Series using the web interface, remote consoles or serial console.

5.1. System Status

System status : /system/sysstatus

System information

Device name :	ProSeries
Serial No. :	PS410-20060624JOJ
F/W Rev. :	v1, 1, 0
Current time :	03/02/2005 09:43:27
System logging :	Enable
Send system log by email :	Disable

IP information

IP mode :	Static
IP address :	192, 168, 4, 41
Subnetmask :	255, 255, 0, 0
Gateway :	192, 168, 1, 1
Receive/Transmit errors :	0/134
Primary DNS :	168, 126, 63, 1
Secondary DNS :	168, 126, 63, 2

Figure 5-1 System status display

5.2. System Logging

The Pro Series provides both the system logging feature and the system log status display. The user may configure the Pro Series to enable or disable the system logging process, the system log buffer size, as well as select the log storage location.

- **System log storage location**

The system log can be stored in the **Pro Series internal memory**, the **mounting point on an NFS server** or the **SYSLOG server**. If the internal memory is used to store system log data, the log data will be cleared when the Pro Series is turned off. To preserve the system log data, set the storage location to be SYSLOG server or NFS server. To do this, the user must configure the corresponding media in advance. Unless the media is properly set up, the log will not be written to a specified storage location properly.

The Pro Series can also be configured to send log data automatically if the number of logs unsent reaches a pre-defined number. If enabled, the user must set parameters to initiate the creation of a email. These parameters would include the number of logs required to trigger an email, the recipient's email address, etc. *Figure 5-2* shows the configuration and system log view screen.

System logging : /system/log/

Enable/Disable system logging	Enable ▾
System log storage location	RAM disk (10 Kbyte) ▾
Enable/Disable E-mail logging	Enable ▾
Number of E-mail Logs	5
Recipient's E-mail Logs	admin@yourcompany.c

[System log view](#)

Copyright 2005 Sena Technologies, Inc. All rights reserved.

Figure 5-2 System log configuration and view

5.3. Change Password

The password for the administrative system user (root) of Pro Series can be changed using this menu. This password is required when user wants to access serial console, telnet/ssh console or Web UI of Pro Series. (Please refer to the section 5.8 User administration for details about port user management)

Change password : /system/changepasswd

User	root
Current Password	<input type="password"/>
New Password	<input type="password"/>
Confirm Password	<input type="password"/>

Figure 5-3 Changing the password

5.4. Device Name Configuration

The Pro Series has its own name for administrative purposes. *Figure 5-4* shows the device name configuration screen. When user changes Device name, hostname of Pro Series will be also changed.

Device Name : /system/device_name/

Device Name

Copyright 2005 Sena Technologies, Inc. All rights reserved.

Figure 5-4 Device name configuration

Please note that user cannot set space character as a device name. If user sets blank as Device name then hostname is set as IP address of Pro Series automatically.

And also the device name is utilized for management program, HelloDevice Manager.

5.5. Date and Time Settings

The Pro Series maintains current date and time information. The PS410/810's clock and calendar settings are backed up by internal battery power. (Please note that PS110 does not have a battery for internal clock. Current date and time setting will not be retained after system rebooting. So it is recommended to use NTP server to maintain correct date and time in PS110 model)

The user can change the current date and time, as shown in *Figure 5-5*.

Date and time : /system/date_time/

Use NTP

Date [mm/dd/yyyy]

Time [hh:mm:ss]

Figure 5-5 Date and time configuration

User also uses the NTP (Network Time Protocol) sever for setting the time of the Pro Series as shown in *Figure 5-6*. If the NTP feature is enabled, the Pro Series will obtain the date and time information from the NTP server at each reboot. If the NTP server is set to 0.0.0.0, the Pro Series will use the default NTP servers. In this case, the Pro Series should be connected from the network to the Internet. The user may also need to set the time offset from UTC depending on the users' location.

Date and time : /system/date_time/

Use NTP	Enable ▾
NTP server (0,0,0,0 for Auto)	0.0.0.0
Time offset from UTC (UTC + [x.x]hours)	0.0

Figure 5-6 NTP configuration

5.6. Factory Reset

The user may restore the factory default settings at any time using this menu. (User can also restore the factory default settings using the reset switch near by serial console port.)

Factory reset : /system/factory

Except IP configuration	<input type="checkbox"/>
-------------------------	--------------------------

Figure 5-7 Factory Reset

5.7. Firmware Upgrade

Firmware upgrades are available via serial, remote console or web interface. The latest upgrades are available on the Sena web site at <http://www.sena.com/support/downloads/>.

Figure 5-8 shows the firmware upgrade web interface.

To upgrade firmware via the web:

1. Select the latest firmware binary by clicking browse button.
2. Select and upload the selected version.
3. Once the upgrade has been completed, the system will reboot to apply the changes.

Firmware upgrade : /system/firmware_up

File Upload	<input type="text"/>	<input type="button" value="찾아보기..."/>
-------------	----------------------	--

Copyright 2005 Sena Technologies, Inc. All rights reserved.

Figure 5-8 Firmware upgrade

To use either a remote or serial console to upgrade your firmware, the TELNET/SSH or terminal emulation program must support Zmodem transfer protocol. The previous settings will be retained after the firmware upgrade.

To upgrade firmware via a remote console:

1. Obtain the latest firmware.
2. Connect the terminal emulation program using either TELNET/SSH or a serial console port.
(TELNET or SSH is recommended since the process of firmware upgrade by serial console requires extremely long time.)
3. Select from the firmware upgrade menu as shown in Figure 5-9

```
login: root
Password:
# editconf

_] / [_____
1. Network configuration
2. Serial port configuration
3. System administration

COMMAND (Display HELP : help)>3

_] System administration [_____
1. System status
2. System logging
3. Device Name : PS110
4. Date and time
5. Change password
6. User Administration
7. Factory reset
8. Firmware upgrade

COMMAND (Display HELP : help)>8

_] Firmware upgrade [_____
Do you want to upgrade firmware? [yes/no] yes
Transfer firmware by zmodem using your terminal application.
To escape, press Ctrl+X
**B0ff000005b157
```

Figure 5-9 Firmware upgrade using remote/serial console

4. Follow the online directions and transfer the firmware binary file using the Zmodem protocol as shown in *Figure 5-10*.
5. Once the upgrade has been completed, the system will reboot to apply the changes
6. If the firmware upgrade fails, the Pro Series will display error messages as shown in *Figure 5-11*. It will also maintain the current firmware version.

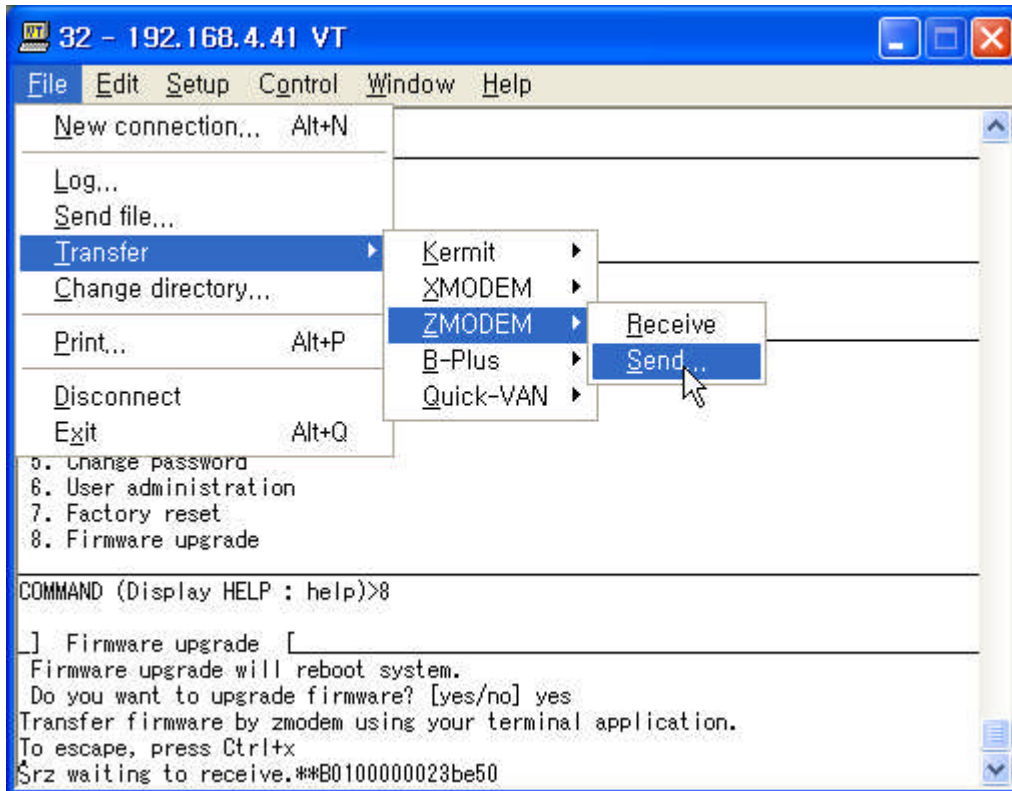

Figure 5-10 Transfer binary file by Zmodem (TeraTerm Pro)

```

_] Firmware upgrade [ ]
Do you want to upgrade firmware? [yes/no] yes
Transfer firmware by zmodem using your terminal application.
To escape, press Ctrl+X
**B0ff000005b157
**B0ff000005b157
**B0ff000005b157
**B0ff000005b157
Firmware upgrade failed !
Now reboot ...

```

Figure 5-11 Firmware upgrade failure message

5.8. User administration

User can enable port authentication (see section 4.2.3.1 TCP mode), then user should enter correct user ID and password of each port when he tries to access the serial port.

The user ID and password for each serial port can be set using this menu. When user adds a new user for serial port, he can also assign permissible serial ports to the user selectively, as shown on Figure 5-12 Port user administration.

User administration : /system/user_auth/

User list

No.	User ID	Port 1	Port 2	Port 3	Port 4	
1	<input type="text" value="user1"/>	<input checked="" type="checkbox"/>	<input type="checkbox"/>	<input type="checkbox"/>	<input type="checkbox"/>	<input type="button" value="REMOVE"/>
2	<input type="text" value="user24"/>	<input type="checkbox"/>	<input checked="" type="checkbox"/>	<input type="checkbox"/>	<input checked="" type="checkbox"/>	<input type="button" value="REMOVE"/>
3	<input type="text" value="user_all"/>	<input checked="" type="checkbox"/>	<input checked="" type="checkbox"/>	<input checked="" type="checkbox"/>	<input checked="" type="checkbox"/>	<input type="button" value="REMOVE"/>
NEW	<input type="text"/>	<input type="checkbox"/>	<input type="checkbox"/>	<input type="checkbox"/>	<input type="checkbox"/>	<input type="button" value="ADD"/>

Figure 5-12 Port user administration

NOTE: System user (root) cannot access serial ports unless he is also added as a port user in this menu.

User list - 1 : /system/user_auth/user_list/*1/

User ID

Password

Password(confirm)

Port 1

Port 2

Port 3

Port 4

Figure 5-13 Port user configuration

To set the password for the port user or to change the configuration of each port user, click the corresponding number associated with the port user on port user administration page, then port user configuration page will be displayed as shown on Figure 5-13 Port user configuration.

6. System Statistics

The Pro Series Web interface provides system statistics menus. The user can use these menus to access statistical data and tables stored in the Pro Series memory. Network interfaces statistics and serial ports statistics display statistical usage of the link layer, **lo**, **eth** and serial ports. IP, ICMP, TCP and UDP statistics display usages of four primary components in the TCP/IP protocol suite.



6.1. Network Interfaces Statistics

Network interfaces statistics displays basic network interfaces usage of the Pro Series, **lo** and **eth0**. **lo** is a local loop back interface and **eth0** is a default network interface of Pro Series.

Network interfaces statistics			
Interface		lo	eth0
Receive	Bytes	680	7448861
	Packets	8	8057
	Errors	0	0
	Drop	0	0
	FIFO	0	0
	Frame	0	0
	Compressed	0	0
	Multicast	0	0
Transmit	Bytes	680	766794
	Packets	8	3991
	Errors	0	0
	Drop	0	0
	FIFO	0	0
	Frame	0	330
	Compressed	0	0
	Multicast	0	0

Figure 6-1 Network interfaces statistics

6.2. Serial Ports Statistics

Serial ports statistics displays the usage history of 32 serial ports, baud rate configurations and each port's pin status. ( : On  : Off)

Serial ports statistics

Port	Baud Rate	Tx	Rx	RTS	CTS	DTR	DSR	CD
1	9600	0	0					
2	9600	0	0					
3	9600	0	0					
4	9600	0	0					

Figure 6-2 Serial ports status

6.3. IP Statistics

The IP Statistics screen provides statistical information about packets/connections using an IP protocol. Definitions and descriptions of each parameter are described below:

Forwarding :

Specifies whether IP forwarding is enabled or disabled.

DefaultTTL :

Specifies the default initial time to live (TTL) for datagrams originating on a particular computer.

InReceives :

Shows the number of datagrams received.

InHdrErrors :

Shows the number of datagrams received that have header errors. Datagrams Received Header Errors is the number of input datagrams discarded due to errors in their IP headers, including bad checksums, version number mismatch, other format errors, time-to-live exceeded, errors discovered in processing their IP options, etc.

InAddrErrors :

Specifies the number of datagrams received that have address errors. These datagrams are discarded because the IP address in their IP header's destination field was not a valid address to be received at this entity. This count includes invalid addresses (for example, 0.0.0.0) and addresses of unsupported Classes (for example, Class E).

ForwDatagrams :

Specifies the number of datagrams forwarded.

InUnknownProtos :

Specifies the number of locally addressed datagrams received successfully but discarded because of an unknown or unsupported protocol.

InDiscard :

Specifies the number of input IP datagrams for which no problems were encountered to prevent

their continued processing, but which were discarded (for example, for lack of buffer space). This counter does not include any datagrams discarded while awaiting reassembly.

InDelivers :

Specifies the number of received datagrams delivered.

OutRequests :

Specifies the number of outgoing datagrams that an IP is requested to transmit. This number does not include forwarded datagrams.

OutDiscards :

Specifies the number of transmitted datagrams discarded. These are datagrams for which no problems were encountered to prevent their transmission to their destination, but which were discarded (for example, for lack of buffer space.) This counter would include datagrams counted in Datagrams Forwarded if any such packets met this (discretionary) discard criterion.

OutNoRoutes :

Specifies the number of datagrams for which no route could be found to transmit them to the destination IP address. These datagrams were discarded. This counter includes any packets counted in Datagrams Forwarded that meet this "no route" criterion.

ReasmTimeout :

Specifies the amount of time allowed for all pieces of a fragmented datagram to arrive. If all pieces do not arrive within this time, the datagram is discarded.

ReasmReqds :

Specifies the number of datagrams that require reassembly.

ReasmOKs :

Specifies the number of datagrams that were successfully reassembled.

ReasmFails :

Specifies the number of datagrams that cannot be reassembled.

FragOKs :

Specifies the number of datagrams that were fragmented successfully.

FragFails :

Specifies the number of datagrams that need to be fragmented but couldn't be because the IP header specifies no fragmentation. For example, if the datagrams "Don't Fragment" flag was set, the datagram would not be fragmented. These datagrams are discarded.

FragCreates :

Specifies the number of fragments created.

IP statistics :

Forwarding	2
DefaultTTL	64
InReceives	222
InHdrErrors	0
InAddrErrors	0
ForwDatagrams	0
InUnknownProtos	0
InDiscard	0
InDelivers	213
OutRequests	203
OutDiscards	0
OutNoRoutes	0
ReasmTimeout	0
ReasmReqds	0
ReasmOKs	0
ReasmFails	0
FragOKs	0
FragFails	0
FragCreates	0

Figure 6-3 IP statistics

6.4. ICMP Statistics

The ICMP Statistics screen provides statistical information about packets/connections using an ICMP protocol. Definitions and descriptions of each parameter are described below:

InMsgs, OutMsgs :

Specifies the number of messages received or sent.

InErrors, OutErrors :

Specifies the number of errors received or sent.

InDestUnreachs, OutDestUnreachs :

Specifies the number of destination-unreachable messages received or sent. A destination-unreachable message is sent to the originating computer when a datagram fails to reach its intended destination.

InTimeExcds, OutTimeExcds :

Specifies the number of time-to-live (TTL) exceeded messages received or sent. A time-to-live exceeded message is sent to the originating computer when a datagram is discarded because the number of routers it has passed through exceeds its time-to-live value.

InParmProbs, OutParmProbs :

Specifies the number of parameter-problem messages received or sent. A parameter-problem message is sent to the originating computer when a router or host detects an error in a datagram's IP header.

InSrcQuenchs, OutSrcQuenchs :

Specifies the number of source quench messages received or sent. A source quench request is sent to a computer to request that it reduces its rate of packet transmission.

InRedirects, OutRedirects :

Specifies the number of redirect messages received or sent. A redirect message is sent to the originating computer when a better route is discovered for a datagram sent by that computer.

InEchos, OutEchos :

Specifies the number of echo requests received or sent. An echo request causes the receiving computer to send an echo reply message back to the originating computer.

NEchoReps, OutEchoReps :

Specifies the number of echo replies received or sent. A computer sends an echo reply in response to receiving an echo request message.

InTimestamps, OutTimestamps :

Specifies the number of time-stamp requests received or sent. A time-stamp request causes the receiving computer to send a time-stamp reply back to the originating computer.

InTimestampReps, OutTimestampReps :

Specifies the number of time-stamp replies received or sent. A computer sends a time-stamp reply in response to receiving a time-stamp request. Routers can use time-stamp requests and replies to measure the transmission speed of datagrams on a network.

InAddrMasks, OutAddrMasks :

Specifies the number of address mask requests received or sent. A computer sends an address mask request to determine the number of bits in the subnet mask for its local subnet.

InAddrMaskReps, OutAddrMaskReps :

Specifies the number of address mask responses received or sent. A computer sends an address mask response in response to an address mask request.

ICMP statistics :

InMsgs	0
InErrors	0
InDestUnreachs	0
InTimeExcds	0
InParmProbs	0
InSrcQuenchs	0
InRedirects	0
InEchos	0
InEchoReps	0
InTimestamps	0
InTimestampReps	0
InAddrMasks	0
InAddrMaskReps	0
OutMsgs	0
OutErrors	0
OutDestUnreachs	0
OutTimeExcds	0
OutParmProbs	0
OutSrcQuenchs	0
OutRedirects	0
OutEchos	0
OutEchoReps	0
OutTimestamps	0
OutTimestampReps	0
OutAddrMasks	0
OutAddrMaskReps	0

Figure 6-4 ICMP statistics

6.5. TCP Statistics

The TCP Statistics screen provides statistical information about packets/connections using a TCP protocol. Definitions and descriptions of each parameter are described below:

RtoAlgorithm :

Specifies the retransmission time-out (RTO) algorithm in use. The Retransmission Algorithm can have one of the following values.

- 0 : CONSTANT - Constant Time-out
- 1: RSRE - MIL-STD-1778 Appendix B
- 2: VANJ - Van Jacobson's Algorithm
- 3: OTHER - Other

RtoMin :

Specifies the minimum retransmission time-out value in milliseconds.

RtoMax :

Specifies the maximum retransmission time-out value in milliseconds.

MaxConn :

Specifies the maximum number of connections. If the maximum number is set to -1, the maximum number of connections are dynamic.

ActiveOpens :

Specifies the number of active opens. In an active open, the client is initiating a connection with the server.

PassiveOpens :

Specifies the number of passive opens. In a passive open, the server is listening for a connection request from a client.

AttemptFails :

Specifies the number of failed connection attempts.

EstabResets :

Specifies the number of established connections that have been reset.

CurrEstab :

Specifies the number of currently established connections.

InSegs :

Specifies the number of segments received.

OutSegs :

Specifies the number of segments transmitted. This number does not include retransmitted segments.

RetransSegs :

Specifies the number of segments retransmitted.

RetransSegs :

Specifies the number of errors received.

OutRsts :

Specifies the number of segments transmitted with the reset flag set.

TCP statistics :

RtoAlgorithm	1
RtoMin	200
RtoMax	120000
MaxConn	-1
ActiveOpens	0
PassiveOpens	20
AttemptFails	0
EstabResets	3
CurrEstab	1
InSegs	194
OutSegs	273
RetransSegs	0
InErrs	0
OutRsts	0

Figure 6-5 TCP statistics

6.6. UDP Statistics

The UDP Statistics screen provides statistical information about packets/connections using a UDP protocol. Definitions and descriptions of each parameter are described below:

InDatagrams :

Specifies the number of datagrams received.

NoPorts :

Specifies the number of received datagrams that were discarded because the specified port was invalid.

InErrors :

Specifies the number of erroneous datagrams that were received. Datagrams Received Errors is the number of received UDP datagrams that could not be delivered for reasons other than the lack of an application at the destination port.

OutDatagrams :

Specifies the number of datagrams transmitted.

UDP statistics :

InDatagrams	0
NoPorts	0
InErrors	0
OutDatagrams	0

Figure 6-6 UDP statistics

7. CLI guide

7.1. Introduction

The **root** user can access the Linux console command line interface (CLI) of the Pro Series via the serial console or TELENT/SSH. In the CLI, the user can perform standard Linux commands to view the status of the Pro Series, edit the configuration, apply configuration changes.

7.2. Flash partition

The Pro Series internal flash is partitioned as shown in the table below. The user can access files at /var directory at his own risk. Simply accessing these files will not affect the Pro Series after rebooting. However, if the user invokes the command saveconf, the changes in the configuration file will be committed to the internal flash memory area of the Pro Series. This will result in the changes being kept after the reboot sequence. Invalid configuration changes can affect the Pro Series behavior. At worst, it may cause the Pro Series to become inoperable.

Block	Type	Mount point	Size (KB)
Mtdblock0	Bios	None	128
Mtdblock1	Kernel & ROM file system	/	1024
Mtdblock2	CRAMFS (Read only)	/mtd	2880
Mtdblock3	EXT2 (R/W)	/cnf (normally unmounted)	64
Total			4096

7.3. Supported Linux Utilities

7.3.1. Shell & shell utilities:

cat, echo, more, pwd

7.3.2. File and disk utils:

ls, cp, mv, rm, mkdir, rmdir, touch, gunzip, gzip, tar, df, du, vi, e2fsck, mount, umount

7.3.3. System utilities:

date, free, hostname, kill, killall, ps, reboot

7.3.4. Network utilities:

ifconfig, iptables, route, ping

7.4. Accessing CLI

Serial console:

- 1) Connect the console port of the Pro Series with the PC serial port
- 2) Run a PC terminal emulation program
- 3) Configure the PC serial port to: 9600-8-N-1 No flow control
- 4) Press <enter>
- 5) Login with the Pro Series root account

Telnet console:

- 1) `telnet Pro_Series_ip_address`

SSH console:

- 1) `ssh -2 Pro_Series_ip_address`

NOTE : The Pro Series support only SSH v2 protocol.

Appendix 1. Connections

A 1.1. Ethernet Pin outs

The Pro Series uses a standard Ethernet connector, which is a shielded connector that is compliant with the AT&T258 specifications. *Table A-1* shows the pin assignment and wire color.

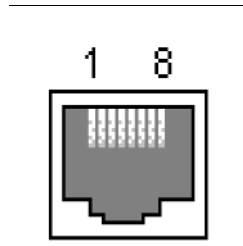

Figure A-1 Pin layout of the RJ45 connector

Table A-1 Pin assignment of the RJ45 connector for Ethernet

Pin	Description	Color
1	Tx+	White with orange
2	Tx-	Orange
3	Rx+	White with green
4	NC	Blue
5	NC	White with blue
6	Rx-	Green
7	NC	White with brown
8	NC	Brown

A 1.2. Console and Serial port pin-outs

The pin assignment of the PS110/PS410/PS810 DB9 connector is summarized in Table A-2. Each pin has a function according to the serial communication type configuration.

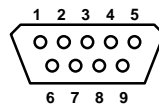

Figure A-2 Pin layout of the DB-9 connector

Table A-2 Pin assignment of DB-9 connector for console and serial port

Pin	RS232 (console and serial ports)	RS422 (serial ports only)	RS485 (serial ports only)
1	DCD	Tx+	Tx+
2	Rx	RX+	RX+
3	Tx	RTS+	-

4	DTR	CTS+	-
5	GND	GND	GND
6	DSR	TX-	TX-
7	RTS	RTS-	-
8	CTS	RX-	RX-
9	-	CTS-	-

The serial communication type can be set by DIP switch near by serial port. (Only for PS110 and PS410) To change the serial communication type, change the position of each DIP switch as shown below. But please note that the power of the Pro Series should be turned off before changing the serial communication type.

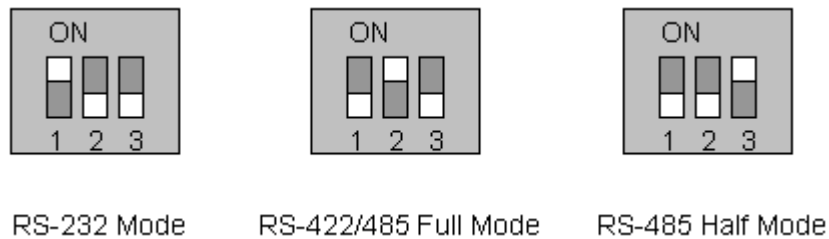

Figure A-3 Serial communication type and DIP switch configuration

A 1.3. Ethernet Wiring Diagram

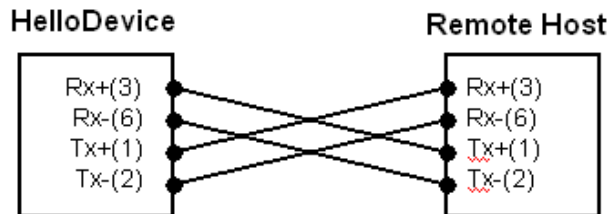

Figure A-4 Ethernet direct connection using crossover Ethernet cable

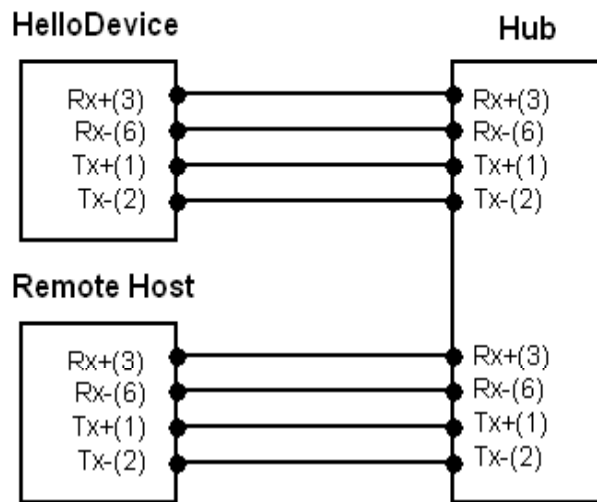

Figure A-5 Ethernet connection using straight through Ethernet cable

A 1.4. Serial Wiring Diagram

A 1.4.1. RS232 Serial Wiring Diagram

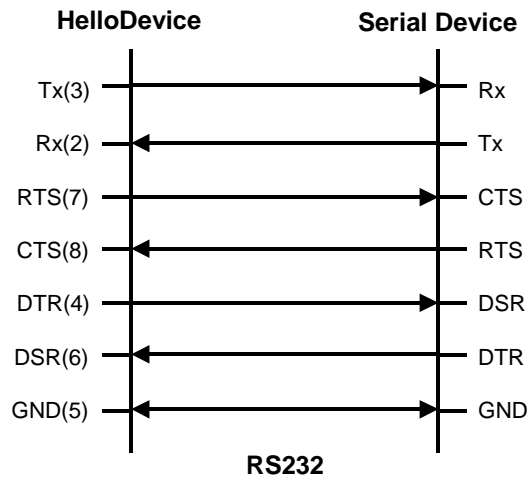
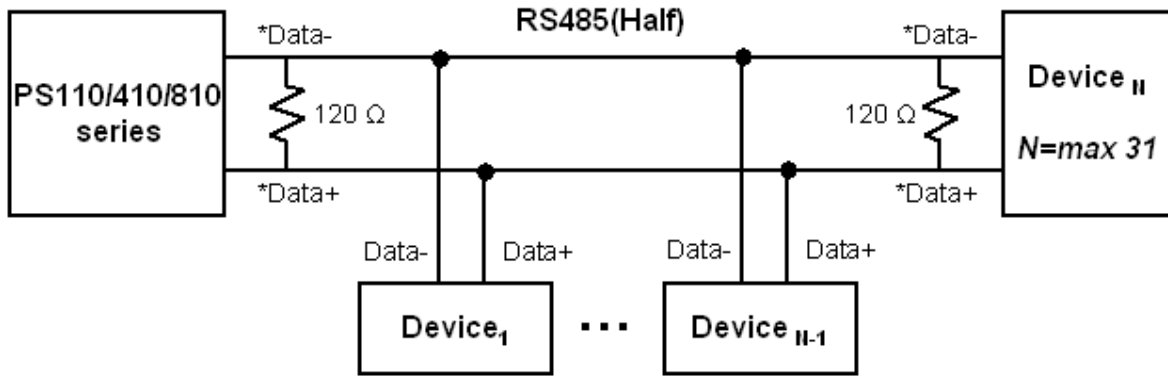

Figure A-6 RS232 wiring diagram

A 1.4.2. RS422/485 Serial Wiring Diagram



*Data+ means that coupling of Tx+(1) pin and Rx+(2) pin

*Data- means that coupling of Tx-(6) pin and Rx-(8) pin

Figure A-7 RS485 wiring diagram

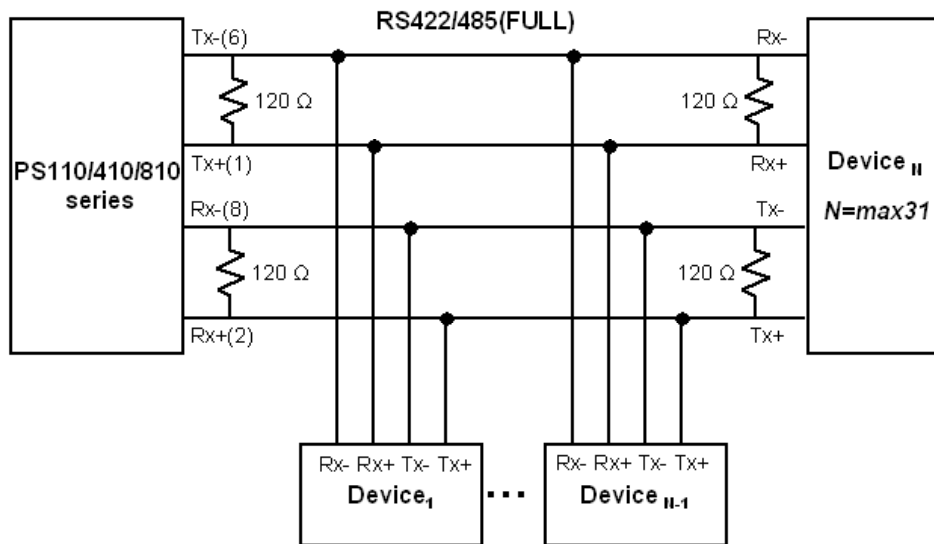

* Termination Resistor at Tx side can be omitted if the signal status is good.

Figure A-8 RS422 wiring diagram

Appendix 2. Pro Series Configuration files

A 2.1. port1.conf

```
/serial/*1/parameter/baudrate=9600
/serial/*1/parameter/databit=0
/serial/*1/parameter/stopbit=0
/serial/*1/parameter/parity=0
/serial/*1/parameter/flowcontrol=0
/serial/*1/parameter/interchar_to=0
/serial/*1/parameter/dtr_option=0
/serial/*1/parameter/dsr_option=0
/serial/*1/modem/modem_init_string=q1e0s0=2
/serial/*1/modem/modem_dcd_option=0
/serial/*1/modem/modem_auto_disconnection_enable=0
/serial/*1/modem/modem_enable=0
/serial/*1/event/event_email_enable=0
/serial/*1/event/event_snmp_enable=0
/serial/*1/event/event_notification_interval=30
/serial/*1/event/event_enable=0
/serial/*1/hostmode/accept_unlisted=1
/serial/*1/hostmode/send_unlisted=1
/serial/*1/enable=1
/serial/*1/title=Port #1
/serial/*1/hostmode/mode=0
/serial/*1/hostmode/port=7001
/serial/*1/hostmode/userauth=0
/serial/*1/hostmode/telnet=0
/serial/*1/hostmode/max_connection=8
/serial/*1/hostmode/cyclic_time=0
/serial/*1/hostmode/inactive_time=0
```

A 2.2. filter.conf

```
/network/filter/specification/telnet=1
/network/filter/specification/ssh=1
/network/filter/specification/http=1
/network/filter/specification/https=1
/network/filter/specification/port1=1
/network/filter/specification/port2=1
/network/filter/specification/port3=1
/network/filter/specification/port4=1
```

A 2.3. snmp.conf

```
/network/snmp/syscontact=administrator
/network/snmp/sysname=ProSeries
/network/snmp/syslocation=my location
/network/snmp/syssservice=7
/network/snmp/powerontrapenable=0
/network/snmp/authtrapenable=1
/network/snmp/linkuptrapenable=0
/network/snmp/logintrapenable=0
/network/snmp/nms/*1=0.0.0.0 public 0
/network/snmp/nms/*2=0.0.0.0 public 0
/network/snmp/nms/*3=0.0.0.0 public 0
/network/snmp/nms/*4=0.0.0.0 public 0
/network/snmp/trap/*1=0.0.0.0 public 0
```

```
/network/snmp/trap/*2=0.0.0.0 public 0  
/network/snmp/trap/*3=0.0.0.0 public 0  
/network/snmp/trap/*4=0.0.0.0 public 0
```

Appendix 3. Well-known port numbers

Port numbers are divided into three ranges: Well Known Ports, Registered Ports, and Dynamic and/or Private Ports. Well Known Ports are those from 0 through 1023. Registered Ports are those from 1024 through 49151. Dynamic and/or Private Ports are those from 49152 through 65535.

Well Known Ports are assigned by IANA, and on most systems, can only be used by system processes or by programs executed by privileged users. *Table A-3* shows some of the well-known port numbers. For more details, please visit the IANA website:

<http://www.iana.org/assignments/port-numbers>

Table A-3 Well-known port numbers

Port number	Protocol	TCP/UDP
21	FTP (File Transfer Protocol)	TCP
22	SSH (Secure Shell)	TCP
23	Telnet	TCP
25	SMTP (Simple Mail Transfer Protocol)	TCP
37	Time	TCP, UDP
39	RLP (Resource Location Protocol)	UDP
49	TACACS, TACACS+	UDP
53	DNS	UDP
67	BOOTP server	UDP
68	BOOTP client	UDP
69	TFTP	UDP
70	Gopher	TCP
79	Finger	TCP
80	HTTP	TCP
110	POP3	TCP
119	NNTP (Network News Transfer Protocol)	TCP
161/162	SNMP	UDP
443	HTTPS	TCP

Appendix 4. Guide to the Bios menu program

A 4.1. Overview

The bios menu provides a way to recover the Pro Series unit, by using TFTP, as a disaster recovery option and to diagnose the system hardware. If the user presses the <ESC> key within 3 seconds after the Pro Series unit is powered up, the user will enter the bios menu program. From this menu program, the user can set various system parameters, test system hardware, and perform firmware upgrades.

NOTE:

For PS110, the bios menu will be displayed only when the Data/Console switch is located at the Console side.

A 4.2. Main menu

After entering the bios menu program, the user will see following main menu page:

```
-----  
BIOS v1.0.0 (c) 1998-2005 Sena Technologies, Inc.  
-----  
  
-----  
Welcome to Boot Loader Configuration page  
-----  
  
Select menu  
1. RTC Configuration  
2. Hardware test  
3. Firmware upgrade [S/W Version : v1.0.0]  
4. Exit and boot from flash  
5. Exit and reboot  
  <ESC> Back, <ENTER> Refresh  
----->
```

Figure A-9 Main Menu Page of Bios Menu

A 4.3. RTC configuration menu

Using the RTC configuration menu, the user can set the system time of the Pro Series. (There is no RTC configuration menu in case of PS110)

```
-----  
RTC Configuration  
-----
```

```
Select Menu
1. Data(mm/dd/yy) : 05/19/05
2. Time(hh:mm:ss) : 15:02:28
<ESC> Back, <ENTER> Refresh
----->1
Enter Current Data(mm/dd/yy) : 05/20/05
Press the ENTER key to continue!!
-----
RTC Configuration
-----
Select Menu
1. Data(mm/dd/yy) : 05/20/05
2. Time(hh:mm:ss) : 15:02:41
<ESC> Back, <ENTER> Refresh
----->2
Enter Current Data(hh:mm:ss) : 15:03:40
Press the ENTER key to continue!!
-----
RTC Configuration
-----
Select Menu
1. Data(mm/dd/yy) : 05/20/05
2. Time(hh:mm:ss) : 15:03:41
<ESC> Back, <ENTER> Refresh
----->
```

Figure A-10 RTC configuration within Bios Menu Program

NOTE : Please note that there is no RTC configuration menu in case PS110.

A 4.4. Hardware test menu

Using the Hardware test menu, the user can test hardware components. There are three hardware test modes:

- One time
- Looping (without External test in Auto test)
- Looping (with External test in Auto test)

If the user selects **One time**, an auto test or each component test is performed just once. In this mode, the ping test to the remote host (server IP address) and UART test are also performed once.

If the user selects **Looping** (without External test in Auto test), the auto test is performed repeatedly until the user presses the <ctrl-c> keys. In this mode, the ping test to the remote host (server IP address) and UART test are not performed.

If the user selects **Looping** (with External test in Auto test)', auto test is performed repeatedly until the user presses the <ctrl-c> keys. And, the ping test to the remote host (server IP address) and UART test are also performed repeatedly.

Note:

To perform the test on the Ethernet and UART properly, the user must connect an Ethernet cable to the Ethernet port of the Pro Series and must plug the loopback connector to all the serial ports of the

Pro Series. There must exist a remote host with a valid IP address. The default server IP address is 192.168.0.128 and it can be changed using the [Firmware Upgrade] menu. Otherwise, the test may not be performed properly.

```
-----  
Hardware Test  
-----  
Select menu  
0. Test Mode - One Time  
1. Auto test  
2. DRAM test  
3. FLASH test  
4. EEPROM test  
5. Ethernet test  
6. UART Mode test  
<ESC> Back, <ENTER> Refresh  
-----> 0  
-----  
Hardware Test  
-----  
Select menu  
0. Test Mode - Looping(Without External test in Auto Test)  
1. Auto test  
2. DRAM test  
3. FLASH test  
4. EEPROM test  
5. Ethernet test  
6. UART Mode test  
<ESC> Back, <ENTER> Refresh  
-----> 0  
-----  
Hardware Test  
-----  
Select menu  
0. Test Mode - Looping(With External test in Auto Test)  
1. Auto test  
2. DRAM test  
3. FLASH test  
4. EEPROM test  
5. Ethernet test  
6. UART Mode test  
<ESC> Back, <ENTER> Refresh  
-----> 0  
-----  
Hardware Test  
-----  
Select menu  
0. Test Mode - One Time  
1. Auto test  
2. DRAM test  
3. FLASH test  
4. EEPROM test  
5. Ethernet test  
6. UART Mode test  
<ESC> Back, <ENTER> Refresh  
----->
```

Figure A-11 Hardware test menu within Bios Menu Program

When the user selects [Auto test], a test of all the hardware components is performed automatically.

```

***** Hardware auto-detect and auto-test *****

[DRAM]
DRAM Test -----[ PASSED]

[FLASH]
FLASH Test -----[ PASSED]

[EEPROM]
EEPROM Test -----[ PASSED]

[ETHERNET]
ETHERNET Test -----[ PASSED]

[UART]
<--Internal Loop Test-->
Port # 1 test in progressing(MODE)-----[ RS232]
                                         (Read/WWrite)-----[ SUCCESS]
Port # 2 test in progressing(MODE)-----[ RS232]
                                         (Read/WWrite)-----[ SUCCESS]
Port # 3 test in progressing(MODE)-----[ RS232]
                                         (Read/WWrite)-----[ SUCCESS]
Port # 4 test in progressing(MODE)-----[ RS232]
                                         (Read/WWrite)-----[ SUCCESS]

<--External Uart Test-->
Port # 1 test in progressing(MODE)-----[ RS232]
                                         (Read/WWrite)-----[ SUCCESS]
                                         (RTS/CTS)-----[ SUCCESS]
                                         (DTR/DSR)-----[ SUCCESS]
Port # 2 test in progressing(MODE)-----[ RS232]
                                         (Read/WWrite)-----[ SUCCESS]
                                         (RTS/CTS)-----[ SUCCESS]
                                         (DTR/DSR)-----[ SUCCESS]
Port # 3 test in progressing(MODE)-----[ RS232]
                                         (Read/WWrite)-----[ SUCCESS]
                                         (RTS/CTS)-----[ SUCCESS]
                                         (DTR/DSR)-----[ SUCCESS]
Port # 4 test in progressing(MODE)-----[ RS232]
                                         (Read/WWrite)-----[ SUCCESS]
                                         (RTS/CTS)-----[ SUCCESS]
                                         (DTR/DSR)-----[ SUCCESS]

***** Hardware auto-detect and auto-test SUMMARY *****
1. DRAM Test -----[ PASSED]
2. FLASH Test -----[ PASSED]
3. EEPROM Test -----[ PASSED]
4. ETHERNET Test -----[ PASSED]
5. UART Test Summary
-----
Port Number |Port Mode | Data Communication Test | RTS/CTS | DTR/DSR |
-----
Port # 1(Internal) | UNKNOWN | FAILED | SKIPPED | SKIPPED |
Port # 1(External) | UNKNOWN | FAILED | FAILED | FAILED |
-----
Port # 2(Internal) | UNKNOWN | FAILED | SKIPPED | SKIPPED |
Port # 2(External) | UNKNOWN | FAILED | FAILED | FAILED |
-----
Port # 3(Internal) | UNKNOWN | FAILED | SKIPPED | SKIPPED |
Port # 3(External) | UNKNOWN | FAILED | FAILED | FAILED |
-----
Port # 4(Internal) | UNKNOWN | FAILED | SKIPPED | SKIPPED |
Port # 4(External) | UNKNOWN | FAILED | FAILED | FAILED |
-----
Hardware test is end. Press any key to return the test menu!!

```

Figure A-12 Hardware test screen within Bios Menu Program

For each hardware component test, the user can skip a test by pressing the <ESC> key.

```
-----  
Hardware Test  
-----  
Select menu  
0. Test Mode - One Time  
1. Auto test  
2. DRAM test  
3. FLASH test  
4. EEPROM test  
5. Ethernet test  
6. UART Mode test  
<ESC> Back, <ENTER> Refresh  
-----> 1  
  
***** Hardware auto-detect and auto-test *****  
  
[DRAM]  
DRAM Test -----[SKIPPED]  
  
[FLASH]  
FLASH Test -----[SKIPPED]
```

Figure A-13 Skip the specific test using ESC key

A 4.5. Firmware upgrade menu

By using the 'Firmware upgrade' menu, the user can upgrade the firmware of the unit. Before firmware upgrade, the user can check the current firmware version by selecting menu item 3 from the Main menu page. The firmware upgrade menu supports only the TFTP protocol for remote firmware download. If the user would like to download firmware from TFTP server, he must also set the IP address for the unit properly. The default IP address for the unit is 192.168.161.5.

For firmware upgrade, a firmware file configured as [Firmware File Name] on the server configured as [Server's IP address] must exist.

```
-----  
Firmware upgrade  
-----  
Select menu  
1. Protocol [TFTP]  
2. IP address assigned to Ethernet interface [192.168.161.5]  
3. Server's IP address [192.168.0.128]  
4. Firmware File Name [ps.img]  
5. Start firmware upgrade  
<ESC> Back, <ENTER> Refresh  
----->
```

Figure A-14 Firmware upgrade menu within Bios Menu Program

If the user selects [Start firmware upgrade], a confirmation message will be displayed on the screen. If the user enters 'y', the firmware upgrade process will start. This process cannot be stopped until it has finished.

```
-----  
Firmware upgrade  
-----  
Select menu  
1. Protocol [TFTP]  
2. IP address assigned to Ethernet interface [192.168.6.6]  
3. Server's IP address [192.168.6.1]  
4. Firmware File Name [ps110a.img]  
5. Start firmware upgrade  
  <ESC> Back, <ENTER> Refresh  
-----> 5  
Firmware upgrade cannot be stopped until finished.  
And all configuration parameters are restored to default values.  
Do you really want to start firmware upgrade(y/n)?y  
  
net trying to load image...  
  
TFTP Boot image(ps110a.img) loading at 0xb00000.. 3019495 Bytes  
  
3019495 bytes receive done.  
  
kernel upgrade start.  
Kernel Block : Write to Flash... done  
kernel upgrade complete.  
Cramfs upgrade start.  
Cramfs Block : Write to Flash... done  
Cramfs upgrade complete.  
Configuration upgrade start.  
Configuration Block : Write to Flash... done  
Configuration upgrade complete.  
  
Firmware upgrade is finished successfully..  
  
-----  
Firmware upgrade  
-----  
Select menu  
1. Protocol [TFTP]  
2. IP address assigned to Ethernet interface [192.168.161.5]  
3. Server's IP address [192.168.0.128]  
4. Firmware File Name [ps.img]  
5. Start firmware upgrade  
  <ESC> Back, <ENTER> Refresh  
----->
```

Figure A-15 Firmware upgrade process

After finishing the firmware upgrade process, the program will display the main menu along with a success message.

Appendix 5. Using Pro Series with Serial/IP

A 5.1. Pro Series vs. Serial/IP options

Table A-4 Pro Series vs. Serial/IP option compatibility matrix table

Serial Port Configuration of Pro Series			Serial/IP Configuration		
Host mode Configuration		Cryptography Configuration	Credentials	Connection Protocol	Security
Host mode	Telnet Protocol	SSL			
TCP	Disabled	None	No login required	Raw TCP connection	Disable
TCP	Enabled	None	No login required	Telnet	Disable
TCP	Disabled	Enabled	No login required	Raw TCP connection	SSLv3 or TLSv1/SSLv3 only
TCP	Enabled	Enabled	No login required	Telnet	SSLv3 or TLSv1/SSLv3 only

Please note that Pro Series support only the SSLv3 encryption method, so user should select one of “SSLv3 or TSLv1” option or “SSLv3 only” option in Serial/IP.

A 5.2. Connection example - Telnet and SSLv3 encryption

Step 1. Set host mode of serial port #1 of Pro Series as follows,

Host mode = TCP,

Port numer = 7001,

Telnet protocol = Enabled

Host mode configuration : /serial/+1/hostmode/

Enable/Disable this port ▾

Port title

Host mode configuration

Host mode ▾

Port number (1024-65535, 0 for only outgoing connections)

User authentication ▾

Telnet support ▾

Max. allowed connection (1-8)

Cyclic connection (sec. 0 : disable)

Inactivity timeout (sec. 0 : unlimited)

Remote host

Cryptography configuration

Serial port parameters

Modem configuration

Port logging configuration

Port event handling configuration

Figure A-16 Host mode configuration

Step 2. Set Cryptography configuration of serial port #1 of Pro Series as follows,

SSL enable = Enable

Cryptography configuration : /serial/+1/ssl/

Enable/Disable this port ▾

Port title

Host mode configuration

Cryptography configuration

SSL enable ▾

Serial port parameters

Modem configuration

Port logging configuration

Port event handling configuration

Figure A-17 Cryptography configuration

Step 3. Open Serial/IP Control Panel and check the COM port you want to use to communicate

with serial port #1 of Pro Series by pressing “Select Ports” button.

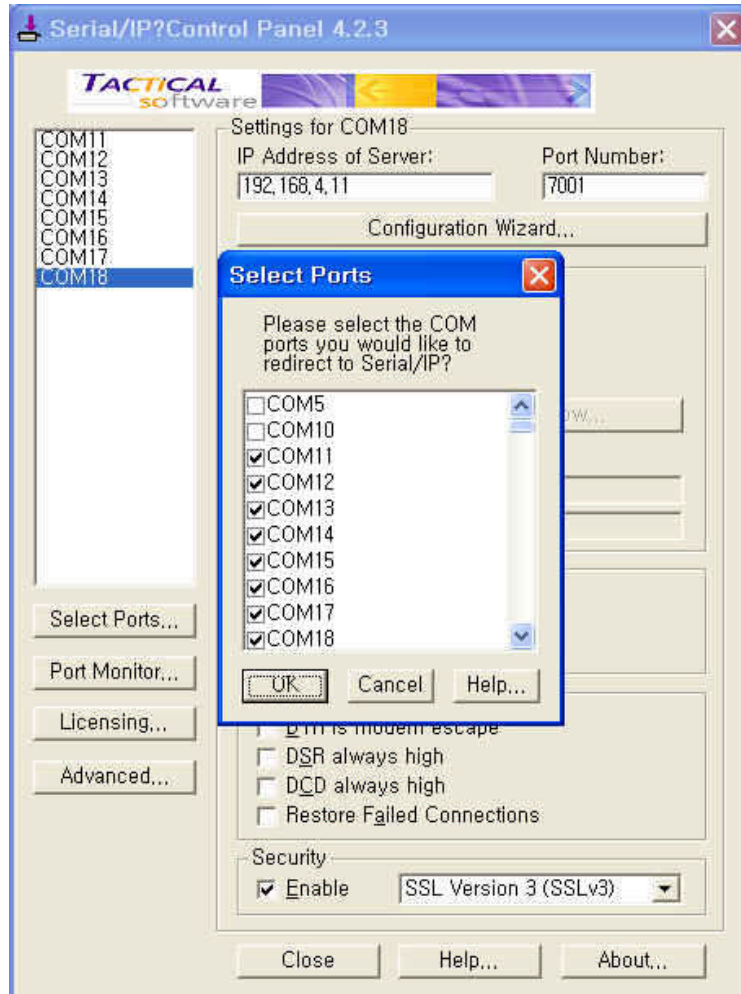

Figure A-18 Select Ports on Serial/IP Control Panel

Step 4. Enter IP address of Server (IP address of Pro Series) and Port number (port number of serial port #1) correctly.

And then select other parameters as follows.

Credentials = No Login Required,

Connection Protocol = Telnet,

Security = SSL Version 3 (SSLv3)

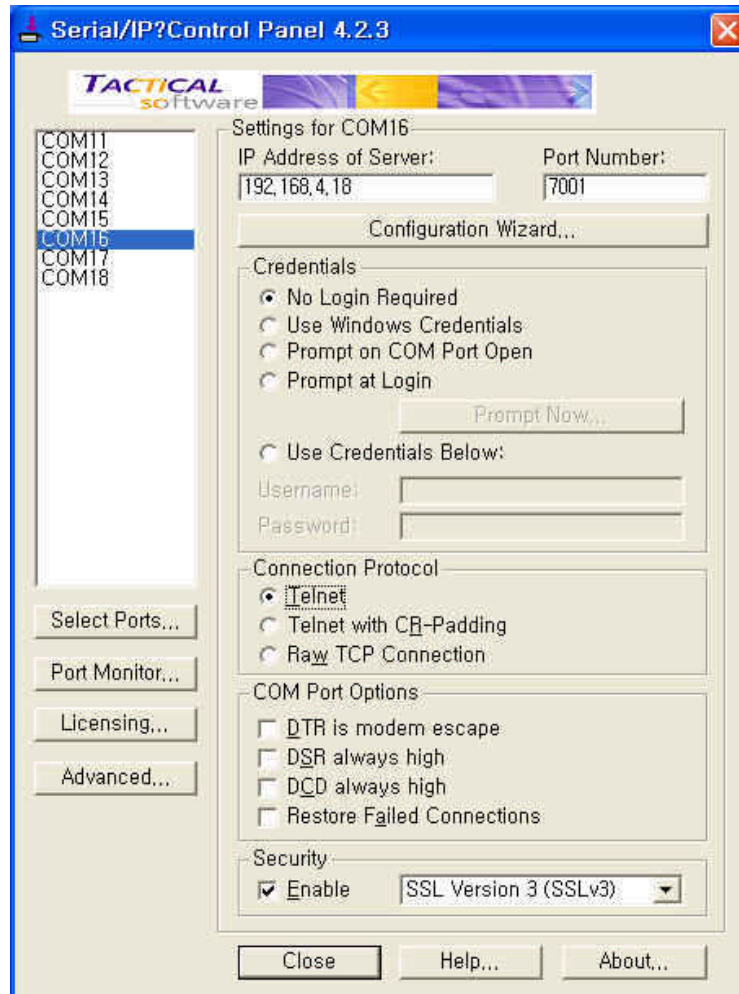

Figure A-19 Set parameters on Serial/IP Control Panel

Step 5. Open the terminal emulation program and select the corresponding COM port.

Then user can use the serial port of Pro series using his local terminal emulation program as if it is one of COM ports on his PC.

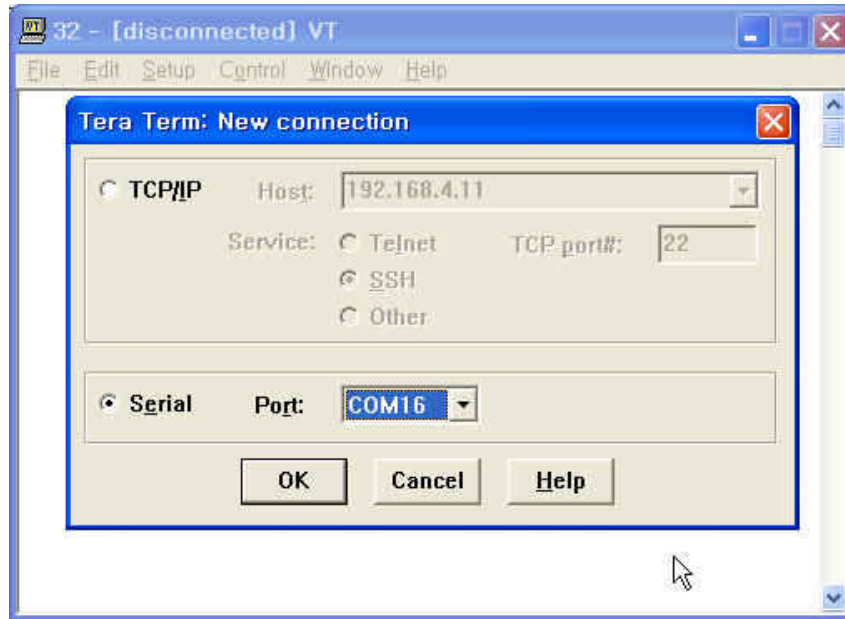

Figure A-20 Connect to serial port of Pro series via Serial/IP

Step 6. User can monitor or trace the connection status using Serial/IP Port Monitor or Trace window.

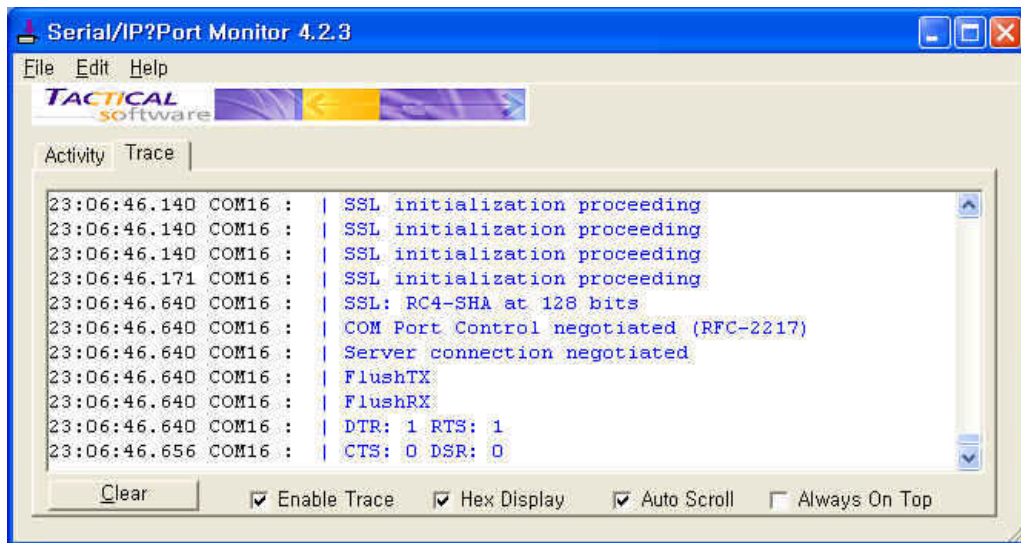

Figure A-21 Serial/IP Trace Window